



## Grid-connected PV Inverter

*FE-120-3P-OG*

*FE-125-3P-OG*

*FE-130-3P-OG*

*FE-135-3P-OG*

*FE-136-3P-OG*

## User Manual



# Contents

<b>1. Introduction</b>	- 1 -
1.1 Appearance Introduction	- 1 -
1.2 Labels description	- 1 -
1.3 Parts list	- 2 -
1.4 Product handling requirements	- 3 -
<b>2. Safety warnings and instructions</b>	- 4 -
2.1 Safety signs	- 4 -
2.2 Safety instructions	- 4 -
2.3 Notes for using	- 5 -
<b>3. Operation Interface</b>	- 5 -
3.1 Interface View	- 5 -
3.2 Status Indicator	- 6 -
3.3 Buttons	- 6 -
3.4 LCD Display	- 6 -
<b>4. Product installation</b>	- 7 -
4.1 Select installation location	- 7 -
4.2 Mounting bracket of inverter	- 9 -
4.3 Installations Tools	- 10 -
4.4 Inverter Installation	- 10 -
<b>5. Electrical Connection</b>	- 11 -
5.1 PV Module Selection	- 11 -
5.2 DC input terminal connection	- 11 -
5.3 AC input terminal connection	- 13 -
5.4 The connection of the ground line	- 15 -
5.5 The inverter monitoring connection	- 16 -
<b>6. Startup and Shutdown</b>	- 17 -
6.1 Start up the inverter	- 17 -
6.2 Inverter Shutdown	- 17 -
6.3 Anti-PID Function(Optional)	- 18 -
6.4 DRM(RCR) wiring diagram(Optional)	- 18 -
6.5 LCD night power supply(Optional)	- 19 -

- 7. Zero-export function via energy meter** ..... - 19 -
  - 7.1 Multiple strings and parallel connection meters ..... - 29 -
  - 7.2 How to browse the load power of your PV grid-tieplant on monitoring platform? - 39 -
- 8. General Operation** ..... - 41 -
  - 8.1 The initial interface ..... - 44 -
  - 8.2 Statistics information ..... - 46 -
  - 8.3 Fault Record ..... - 48 -
  - 8.4 ON/OFF setting ..... - 49 -
  - 8.5 Parameter setting ..... - 50 -
- 9. Repair and Maintenance** ..... - 56 -
- 10. Error information and processing**..... - 56 -
  - 10.1 Error code ..... - 56 -
- 11. Specification** ..... - 61 -

## About This Manual

The manual mainly describes the product information, guidelines for installation, operation and maintenance. The manual cannot include complete information about the photovoltaic (PV) system.

## How to Use This Manual

Read the manual and other related documents before performing any operation on the inverter. Documents must be stored carefully and be available at all times. **Contents may be periodically updated or revised due to product development. The information in this manual is subject to change without notice.** The latest manual can be acquired via [customerservice@festonsev.com](mailto:customerservice@festonsev.com)

## 1. Introduction

### 1.1 Appearance Introduction

On-grid inverter can convert solar panel DC power into AC power which can directly input to the grid. Its appearance is shown below. These models contain FE-120-3P-OG, FE-125-3P-OG, FE-130-3P-OG, FE-135-3P-OG, FE-136-3P-OG.

The following is collectively referred to as “inverter” .

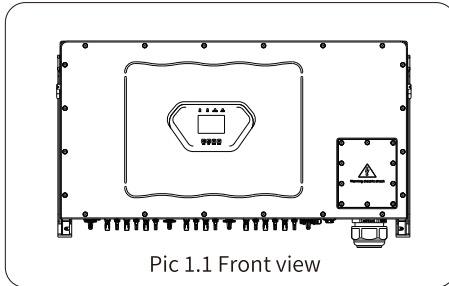



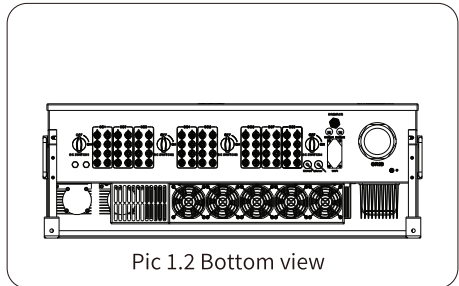

Pic 1.1 Front view



Pic 1.2 Bottom view











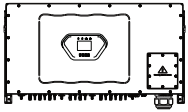

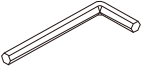
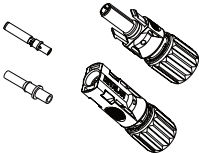
### 1.2 Labels description

\*Note: for some hardware version don't have DRM

Label	Description
	Caution, risk of electric shock symbol indicates important safety instructions, which if not correctly followed, could result in electric shock.
	The DC input terminals of the inverter must not be grounded.
	CE mark of conformity
	Please read the instructions carefully before use.
	Symbol for the marking of electrical and electronics devices according to Directive 2002/96/EC. Indicates that the device, accessories and the packaging must not be disposed as unsorted municipal waste and must be collected separately at the end of the usage. Please follow Local Ordinances or Regulations for disposal or contact an authorized representative of the manufacturer for information concerning the decommissioning of equipment.

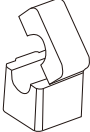
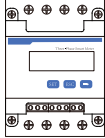
### 1.3 Parts list

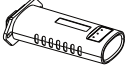
Please check the following table, to see whether all the parts are included in the package:

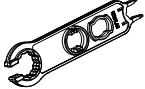
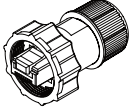
 <p>Grid-tied PV String Inverter x 1</p>	 <p>Wall mounting bracket set x 1</p>	 <p>Mounting stainless steel screws M4×12 x 11</p>	
 <p>Wrench x 2</p>	 <p>DC+/DC- Plug connectors including metal terminal x N pairs</p>	 <p>Stainless steel anti-collision bolt M12×60 x 4</p>	
 <p>T-type wrench x1</p>	 <p>Installation screws M5×16 x 8</p>	 <p>O-Type cold-pressed terminal (RNB38-8 copper) Ground terminal ×1</p>	 <p>C45 flake cold-pressed terminal (C-95<sup>2</sup> Copper purple copper) x 4</p>
 <p>*Sensor Clamp(optional) x 3</p>	 <p>Meter(optional) x 1</p>	 <p>HJA4 Core Wire Female Connector - Screw Crimp x1</p>	 <p>Datalogger (optional) x1</p>
 <p>User manual x1</p>	 <p>Solar Photovoltaic Connector Special Spanner x1</p>	 <p>DRM connector (optional) x1</p>	

## 1.4 Product handling requirements

Lift the inverter out of the packing box and transport it to designated installation location.

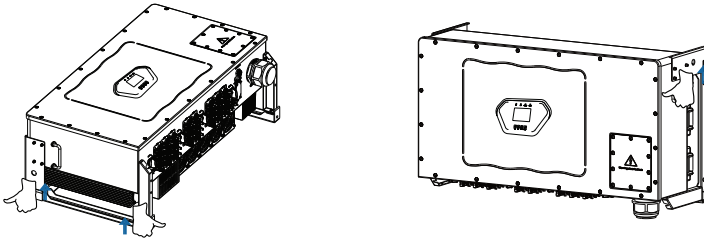

transport



### CAUTION:

Improper handling may cause personal injury!

- Arrange an appropriate number of personnel to carry the inverter according to its weight, and installation personnel should wear protective equipment such as anti-impact shoes and gloves.
- Placing the inverter directly on a hard ground may cause damage to its metal enclosure. Protective materials such as sponge pad or foam cushion should be placed underneath the inverter.
- Move the inverter by one or two people or by using a proper transport tool.
- Move the inverter by holding the handles on it. Do not move the inverter by holding the terminals.

## Hoisting Notes

If the inverter is installed in a high position, you can hung it up.

Only trained and approved personnel are allowed to perform hoisting operations.

- Install temporary warning signs or fences to far away the hoisting area.
- Make sure that the foundation where hoisting is performed on meets the load bearing requirements.
- Before hoisting objects, make sure that hoisting tools are firmly secured onto a fixed object or wall that meets the load-bearing requirements.
- When hoisting, do not stay under the crane or the hoisted objects.
- Do not drag steel ropes and hoisting tools or bump the hoisted things against hard things when hoisting.

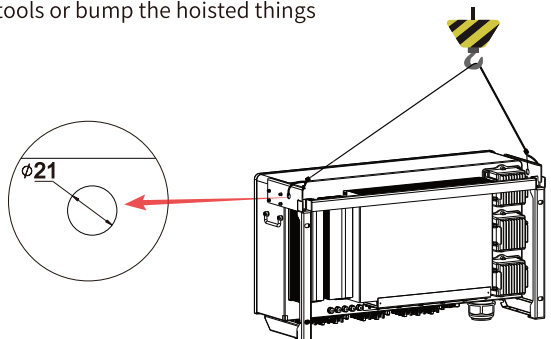

## 2. Safety warnings and instructions

Improper use may result in potential electric shock hazards or burns. This manual contains important instructions that should be followed during installation and maintenance. Please read these instructions carefully before use and keep them for future reference.

### 2.1 Safety signs

Safety symbols used in this manual, which highlight potential safety risks and important safety information, are listed as follows:



**Warning:**

Warning symbol indicates important safety instructions, which if not correctly followed, could result in serious injury or death.



**Shock Hazard:**

Caution, risk of electric shock symbol indicates important safety instructions, which if not correctly followed, could result in electric shock.



**Safety Hint:**

Note symbol indicates important safety instructions, which if not correctly followed, could result in some damage or the destruction of the inverter.



**High Temperature Hazard:**

Caution, hot surface symbol indicates safety instructions, which if not correctly followed, could result in burns.

### 2.2 Safety instructions



**Warning:**

Electrical installation of the inverter must conform to the safety operation rules of the country or local area.



**Warning:**

Inverter adopts non-isolated topology structure, hence must insure DC input and AC output are electrical isolated before operating the inverter.



**Shock Hazard:**

Prohibit disassembling inverter case, there existing shock hazard, which may cause serious injury or death, please ask qualified person to repair.



**Shock Hazard:**

When PV module is exposed to sunlight, the output will generate DC voltage. Prohibit touching to avoid shock hazard.



5min

**Shock Hazard:**

While disconnect the input and output of the inverter for maintenance, please waits for at least 5 mins until the inverter discharge the remnant electricity.



**High Temperature Hazard:**

Local temperature of inverter may exceed 80°C while under operating. Please do not touch the inverter case.

## 2.3 Notes for using

The three phase string power inverter is designed and tested under related safety regulations. It can ensure the personal safety of the user. But as a electric device, it may cause shock or injury by incorrect operation. Please operate the unit under below requirements:

1. Inverter should be installed and maintained by qualified person under local standard regulations.
2. Must disconnect the AC side first, then disconnect DC side while doing installation and maintenance, after that, please wait at least 5 mins to avoid getting shocked.
3. Local temperature of the inverter may exceed 80 °C while under operating. Do not touch to avoid getting injured.
4. All electrical installation must be in accord with local electrical standards, and after obtaining the permission of the local power supply department, the professionals can connect the inverter to the grid.
5. Please take appropriate anti-static measure.
6. Please install where children can not touch.
7. The steps to start the inverter: 1) switch on the AC side circuit breaker, 2) Switch on the DC side circuit breaker of the PV panel. 3) Turn on the DC switch of the inverter.  
The steps to stop the inverter: 1) switch off the AC side circuit breaker, 2) switch off the DC side circuit breaker of the PV panel. 3) Turn off the DC switch of the inverter.
8. Don't insert or remove AC and DC terminals when the inverter is in normal operation.
9. The DC input voltage of the inverter must not exceed the maximum value of the model.

## 3. Operation Interface

### 3.1 Interface View

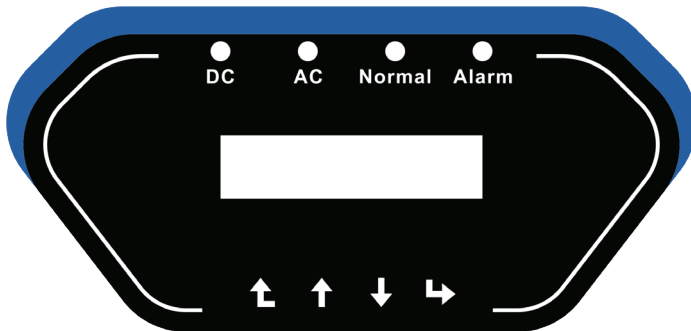

Pic 3.1 Front panel display

### 3.2 Status Indicator

The inverter panel has 4 indicators, the left one is dc output indicators, green indicates normal DC input. Beside is the AC indicator, green indicating normal ac connection. Beside the AC indicator is the operating indicator, green indicating normal output. The right indicator is alarm. red indicates alarming.

Indicator	status	Explanation
● DC	on	Inverter detects DC input
	off	Low DC input voltage
● AC	on	Grid Connected
	off	Grid Unavailable
● NORMAL	on	Under normal operating
	off	Stop operating
● ALARM	on	Detected faults or report faults
	off	Under normal operating

Table 3.1 Status indicator lights

### 3.3 Buttons

There are four buttons on the inverter panel: Above is Up and increase button(UP), Below is down and decrease button(DOWN), Left is ESC button(ESC), Right is Enter button(ENTER). Achieving below functions by the four buttons:

- Page turning (use UP and DOWN button)
- Modify adjustable parameters (use ESC and ENTER button)

### 3.4 LCD Display

Three phase string inverter use 256\*128 dot formation display, Display below content:

- Inverter operation status and information;
- Operating information;
- Warning message and malfunction display.

## 4. Product installation

### 4.1 Select installation location

To select a location for the inverter, the following criteria should be considered:

WARNING: Risk of fire

- Do not install the inverter in areas containing highly flammable materials or gases.
- Do not install the inverter in potentially explosive atmospheres.
- Do not install in small closed spaces where air can not circulate freely. To avoid overheating, always make sure the flow of air around the inverter is not blocked.
- Exposure to direct sunlight will increase the operational temperature of the inverter and may cause output power limiting. It is recommended that inverter installed to avoid direct sunlight or raining.
- To avoid overheating ambient air temperature must be considered when choosing the inverter installation location. It is recommended that using a sun shade minimizing direct sunlight when the ambient air temperature around the unit exceeds 104°F/40°C.



- Install on a wall or strong structure capable of bearing the weight.
- Install vertically with a maximum incline of +15°. If the mounted inverter is tilted to an angle greater than the maximum noted, heat dissipation can be inhibited, and may result in less than expected output power.
- If install more than one inverter, must leave at least 500mm gap between each inverter. And each inverter must be at least 500mm above and below. And must install the inverter at the place where children cannot touch. Please see picture 4.3.
- Consider whether the installation environment is helpful to see the inverter LCD display and indicator status clearly.
- Must offer a ventilate environment if inverter installed in the airtight house.



**Safety Hint:**

Do not place or store any items next to the inverter.

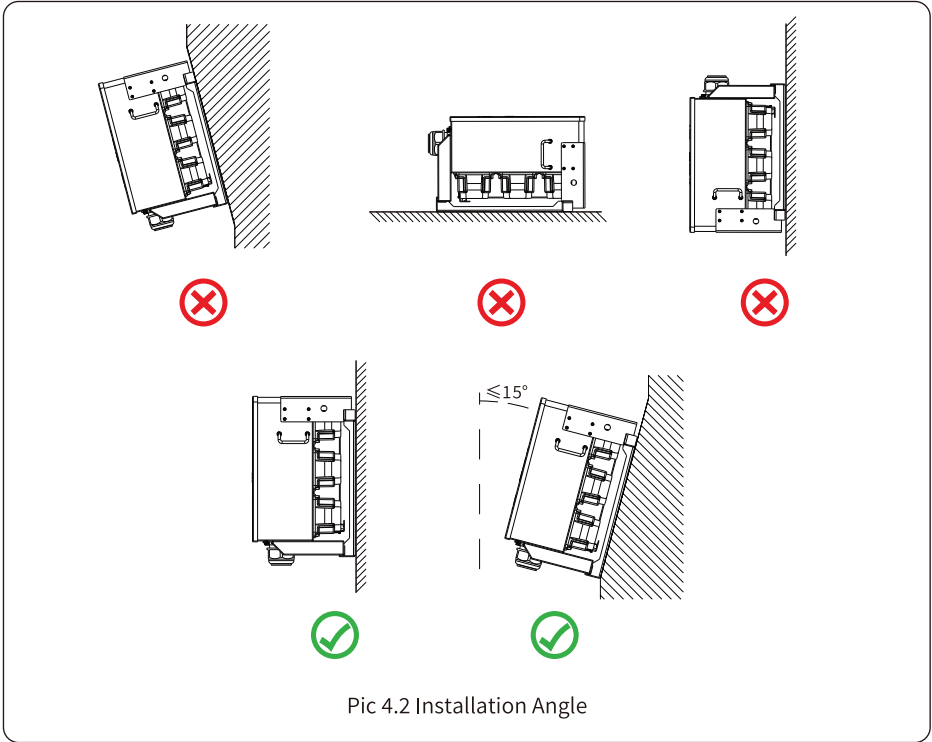

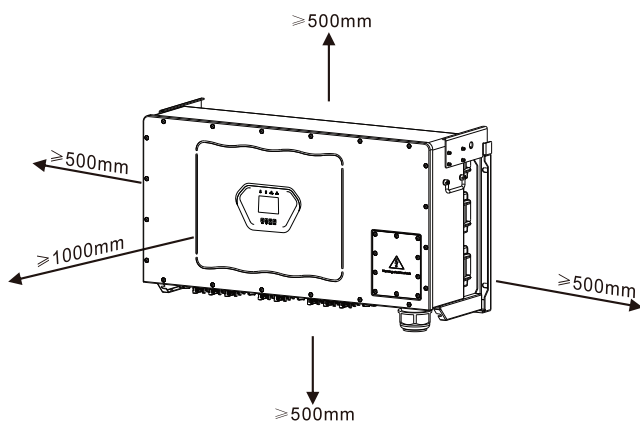

Pic 4.3 Installation Gap

## 4.2 Mounting bracket of inverter

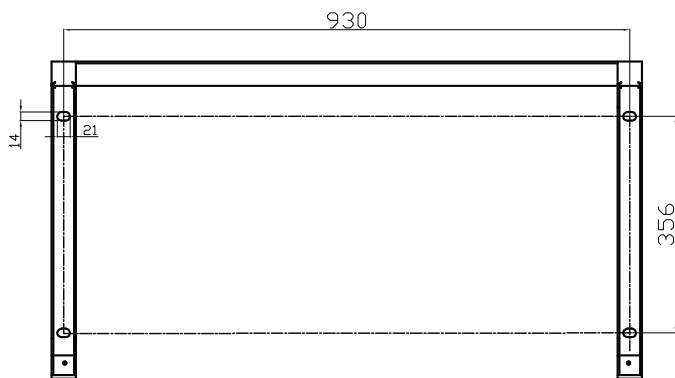











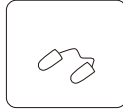

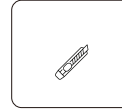

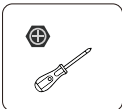
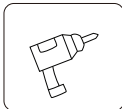
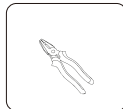
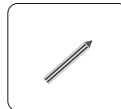
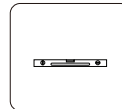

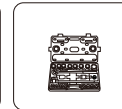
Pic 4.4 Mounting bracket dimensions

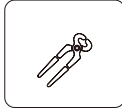
### 4.3 Installations Tools

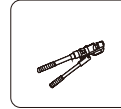
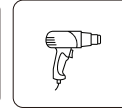
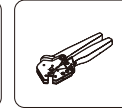
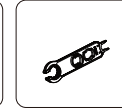
Installation tools can refer to the following recommended ones. Also, use other auxiliary tools on site.

table 4-1 Tool specification

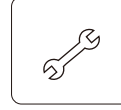
						
Protective goggles	Anti-dust mask	Earplugs	Work gloves	Work shoes	Utility Knife	Slotted screwdriver
						
Cross screwdriver	Percussion drill	Pliers	Marker	Level	Rubber hammer	socket wrenches set
						
Anti-static wrist strap	Wire cutter	Wire stripper	Hydraulic pliers	Heat gun	Crimping tool4-6mm <sup>2</sup>	Solar connector wrench
						
Multimeter ≥1100 Vdc	RJ45 crimping plier	Cleaner	Spanner			

### 4.4 Inverter Installation

The inverter should be mounted in a vertical position. The steps of mounting are as follows

1. For brick walls, the position of the holes should be suitable for the expansion bolts.
2. Make sure the bracket is horizontal and the mounting holes are in the correct points. Drilling the holes on the wall according the marks.
3. Using the expansion bolts to fix the bracket to the wall.

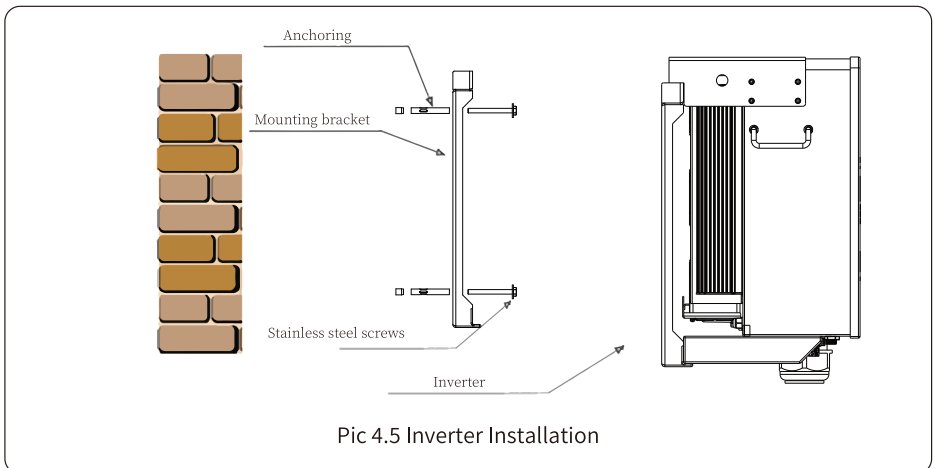

Pic 4.5 Inverter Installation

## 5. Electrical Connection

### 5.1 PV Module Selection:

When selecting proper PV modules, please be sure to consider below parameters:

- 1) Open circuit Voltage (Voc) of PV modules not exceeds max. PV array open circuit voltage of inverter.
- 2) Open circuit Voltage (Voc) of PV modules should be higher than min. start voltage.
- 3) The PV modules used to connected to this inverter shall be Class A rating certified according to IEC 61730.

Inverter Model	FE-120/125/130/135/136-3P-OG
PV Input Voltage	600V (250V-1100V)
PV Array MPPT Voltage Range	200V-1000V
No. of MPP Trackers	8
No. of Strings per MPP Tracker	4+4+4+4+4+4+4+4

### 5.2 DC input terminal connection

1. Switch the Grid Supply Main Switch(AC)OFF.
2. Switch the DC Isolator OFF.
3. Assemble PV input connector to the inverter.



**Warning:**

When using PV modules, please ensure the PV+ & PV- of solar panel is not connected to the system ground bar.



**Safety Hint:**

Before connection, please make sure the polarity of the output voltage of PV array matches the “DC+” and “DC-” symbols.



**Warning:**

Before connecting inverter, please make sure the PV array open circuit voltage is within the 1100V of the inverter.



Pic 5.1 DC+ male connector



Pic 5.2 DC- female connector



**Safety Hint:**

Please use approved DC cable for PV system.

Cable type	Cross section (mm <sup>2</sup> )	
	Range	Recommended value
Industry generic PV cable (model: PV1-F)	2.5-4.0 (12-10AWG)	2.5(12AWG)

Table 5.1 DC Cable Specifications

The steps to assemble the DC connectors are listed as follows:

- a) Strip off the DC wire about 7mm, disassemble the connector cap nut (see picture 5.3).

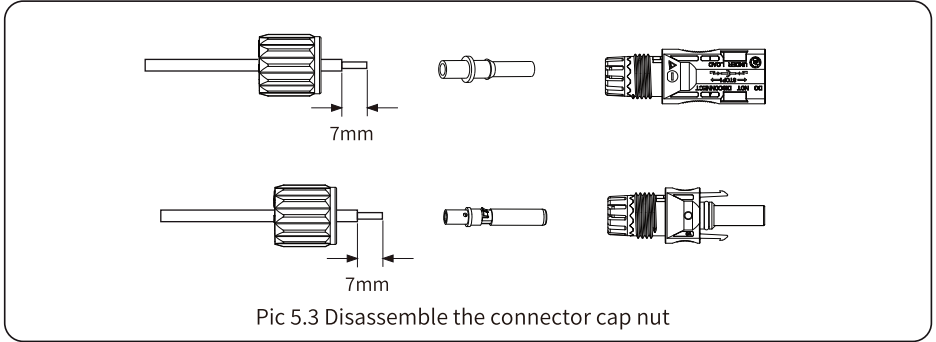

Pic 5.3 Disassemble the connector cap nut

- b) Crimping metal terminals with crimping pliers as shown in picture 5.4.

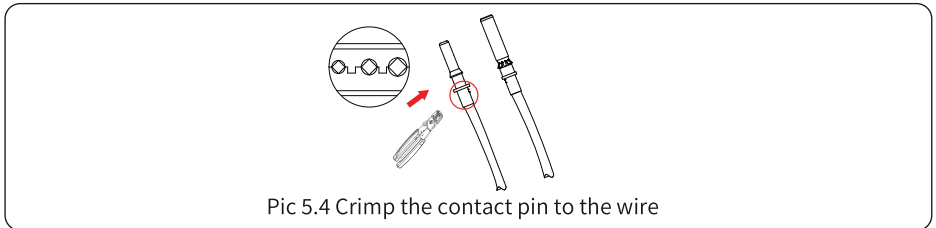

Pic 5.4 Crimp the contact pin to the wire

- c) Insert the contact pin to the top part of the connector and screw up the cap nut to the top part of the connector. (as shown in picture 5.5).

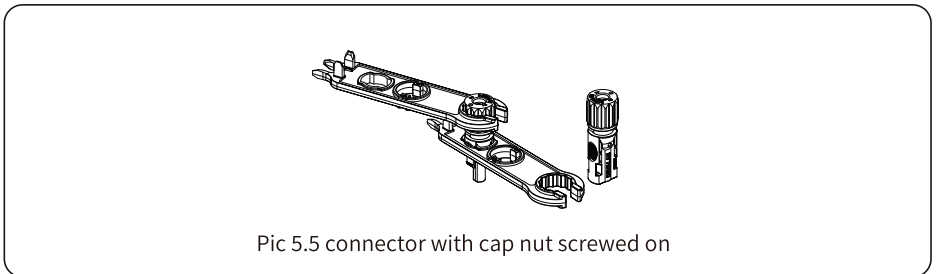

Pic 5.5 connector with cap nut screwed on

d) Finally insert the DC connector into the positive and negative input of the inverter, shown as picture 5.6

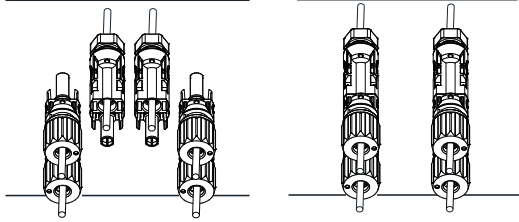

Pic 5.6 DC input connection



**Warning:**

Sunlight shines on the panel will generate voltage, high voltage in series may cause danger to life. Therefore, before connecting the DC input line, the solar panel needs to be blocked by the opaque material and the DC switch should be 'OFF', otherwise, the high voltage of the inverter may lead to life-threatening conditions.



**Warning:**

Please use its own DC power connector from the inverter accessories. Do not interconnect the connectors of different manufacturers. Max. DC input current should be 20A. if exceeds, it may damage the inverter and it is not covered by Deye warranty.

### 5.3 AC terminal connection

Model	Wire Size	Recommend copper cable(mm <sup>2</sup> )	Torque value(max)	Max cable length
FE-120-3P-OG	4/0AWG	95	28.2Nm	Outside cable (3L+N)20m
FE-125-3P-OG	4/0AWG	95	28.2Nm	
FE-130-3P-OG	4/0AWG	95	28.2Nm	
FE-135-3P-OG	4/0AWG	95	28.2Nm	
FE-136-3P-OG	4/0AWG	95	28.2Nm	

Table 5.2 Recommended cable specifications



**Warning:**

The AC cable line L1 is connected to socket 1; L2 is connected to socket 2; L3 is connected to socket 3, the PE line is connected to the earth , the N wire is connected to the socket of N.

AC wire installation method:

1) Remove the 10 screws on the inverter junction box and remove the junction box cover in Pic 5.7. After removing the junction box, you can see the terminals of the inverter. The default is 4 digits as shown in Pic 5.8.

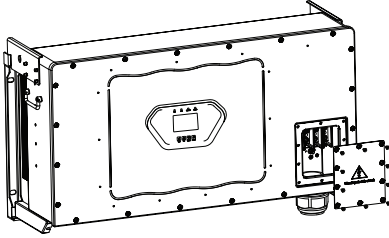

Pic 5.7 AC junction box

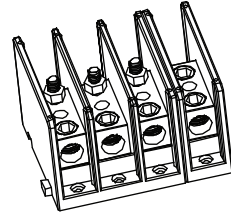

Pic 5.8 AC terminal

2) Connect the cable through the junction box, waterproof jacket, and insert into the terminal (The picture Pic 5.9 shows the connection mode of three phase lines connected to the junction box, ground wire screwed on the inverter shell), and use hexagon screwdriver to presses the wiring harness to the connect terminal as shown in Pic 5.10. Wiring hole diameter is 16mm.

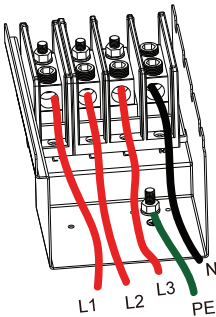

Pic 5.9 Connect AC wires to the terminals

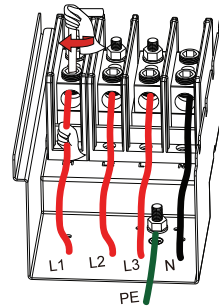

Pic 5.10 Tighten the screws on the terminals

3) Screw the AC connection cover back to the shell and tighten all the screws to tighten the waterproof protection connector, as shown in Pic 5.11

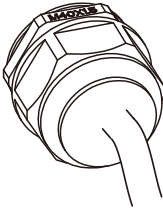

Pic 5.11 Tighten the AC junction box

**5.3.1 Recommended current protector specifications**

Inverter	Rated voltage	Rated output power(KW)	Current protection device (A)
FE-120-3P-OG	400	120	260
FE-125-3P-OG	400	125	270
FE-130-3P-OG	400	130	270
FE-135-3P-OG	400	135	270
FE-136-3P-OG	400	136	270

Table 5.3 Recommended current protector specifications

**5.4 The connection of the ground line**

Good grounded is important for resist the surge voltage shock and improve EMI's performance. So before the connection of AC, DC, communication connections, inverter needs to ground first. For a single system, just ground the PE cable; For multiple machine systems, all PE cables of the inverter need to be connected to the same grounding copper platoon to ensure the equipotent connection. The installation of the shell ground wire is shown as Pic 5.12.

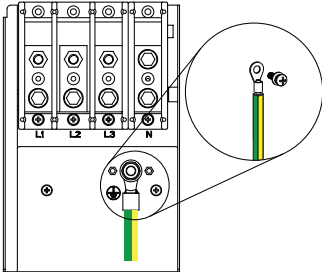

Pic 5.12 The installation of the shell ground wire

Model	Wire Size	Recommend copper cable(mm <sup>2</sup> )	Torque value(max)
FE-120-3P-OG	0AWG	50	20.3Nm
FE-125-3P-OG	0AWG	50	20.3Nm
FE-130-3P-OG	0AWG	50	20.3Nm
FE-135-3P-OG	0AWG	50	20.3Nm
FE-136-3P-OG	0AWG	50	20.3Nm

Table 5.3 Recommended cable specifications



**Warning:**

Inverter has built-in leakage current detection circuit, The type A RCD can be connected to the inverter for protection according to the local laws and regulations. If an external leakage current protection device is connected, its operating current must be equal to 300 mA or higher, otherwise inverter may not work properly.

**5.5 The inverter monitoring connection**

Inverter has the function of wireless remote monitoring inverter. The inverter has Wifi function and Wifi Plug in the accessories is used to realize the connection between the inverter and the network. The operation, installation, networking, APP download are detailed in the WIFI PLUG instructions. Figure 5.13 is the Internet monitoring solution.

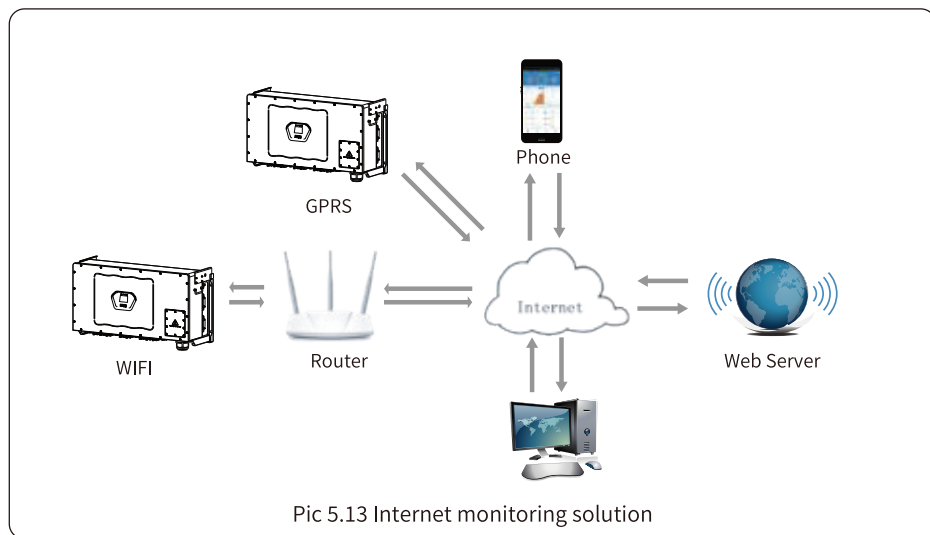

Pic 5.13 Internet monitoring solution

### 5.4.1 Installation of datalogger

When installing the WiFi stick, tear off the sealing strip on the inverter. Insert the datalogger into the interface and fix it with a screw. The configuration of the datalogger needs to be performed after various electrical connections have been completed and the inverter DC power on. When the inverter is on the DC power, it is determined whether the datalogger is normally electrified (The LED light shines out of the shell).

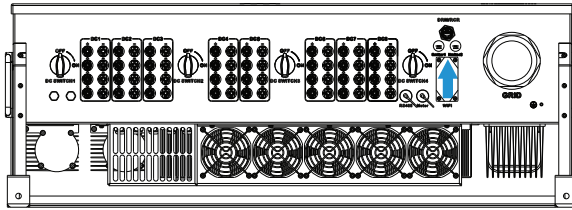

Pic 5.14 datalogger installation diagram

### 5.4.2 Configuration of datalogger

For the configuration of datalogger, please refer to illustrations of the datalogger.

## 6. Start up and Shut off

Ensure that the inverter meets the following conditions before starting the inverter, otherwise it may cause fire or damage to the inverter without quality assurance, at the same time the situation on our company does not undertake any responsibility. At the same time, to optimize the system configuration, it is recommended that the two inputs be connected to the same number of PV modules.

- a). The maximum open circuit voltage of each set of PV modules shall not exceed 1100Vdc under any conditions.
- b). Each input of the inverter better use the same type of PV module in series.
- c). Total output power of PV shall not exceed the maximum input power of inverter, each PV modules shall not exceed the rated power of each channel.

### 6.1 Start up the inverter

When starting up the inverter, should follow steps below:

1. Starting switch on the AC breaker.
2. Turn on the DC switch of the PV module, and if the panel provides sufficient starting voltage and power, the inverter will start.
3. The inverter will first check the internal parameters and the grid parameters, while the liquid crystal will show that the inverter is self-checking.
4. If the parameter is within acceptable range, the inverter will generate energy. NORMAL indicator light is on.

### 6.2 Shut off the inverter

Must follow below steps while Shutting down the inverter:

1. Switch off the AC breaker.
2. Wait for 30 seconds, turn off the dc switch (if any), or simply disconnect the dc input connector. The inverter will close the LCD and all led within two minutes.

### 6.3 Anti-PID Function(Optional)

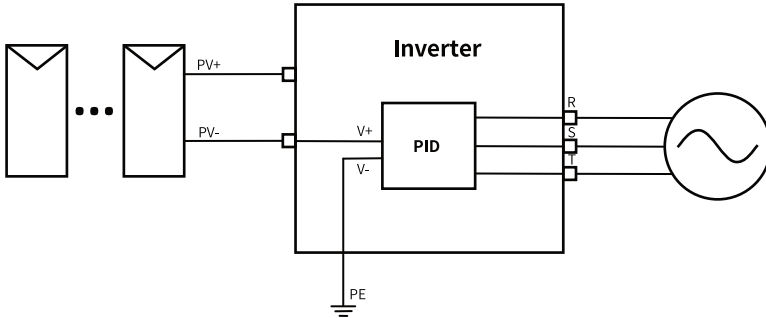

The Anti-PID module repairs the PID effect of the PV module at night. The PID module always runs when connected to AC.

If maintenance is required and turn off the AC switch can disable the Anti-PID function.



#### Warning:

The PID functionality is automatic. When the DC bus voltage is below 50VDC, the PID module will create 450VDC between the PV and ground. No control and equipment are required.



#### Warning:

If you need to maintain the inverter, please turn off the AC switch first, then turn off the DC switch, and wait 5 minutes before you do other operations.

### 6.4 DRM(RCR) wiring diagram(Optional)

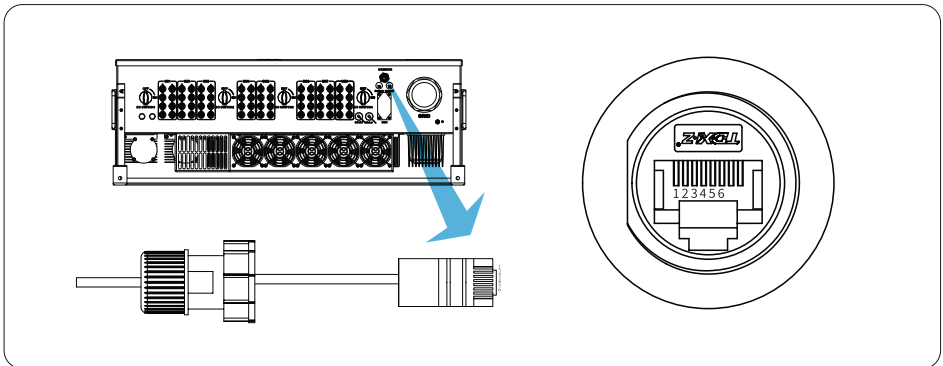

"AU"/"NZ": Demand Response Modes(DRMs)

In Australia and New Zealand, the inverter supports the demand response modes as specified in the standard AS/NZS 4777.2 as shown in Pic 6.1.

"DE": Ripple Control Receiver (RCR)

In Germany, the grid company uses the Ripple Control Receiver to convert the grid dispatching signal and send it as a dry contact signal. The inverter can control power output according to the local preset instructions as shown in Pic 6.2.

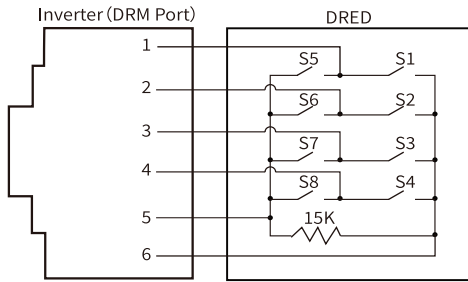

Pic 6.1

Pin	Definition
1	DRM1/5
2	DRM2/6
3	DRM3/7
4	DRM4/8
5	REF GEN/0
6	GND

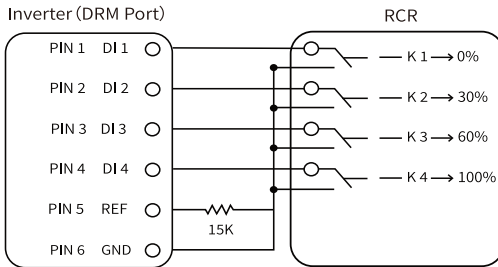

Pic 6.2

Pin	Definition	Note
1	K1	0% Output Power
2	K2	30% Output Power
3	K3	60% Output Power
4	K4	100% Output Power
6	GND	Signal

## 6.5 LCD night power supply(optional)

This function need adding night power PCB board which using AC power to supply the LCD screen and data logger,then the inverter can upload consumption power data to the cloud platform during night. This feature is optional.

## 7. Zero-export function via energy meter

There're several usable models of smart meters for this series inverter. Pic 7.6,7.8,7.14,7.16 is CT Type meters,this Type meter can measure large current on each phase.For example,SDM630MCT 40mA(grid each phase current < 200A),DTSU666 250A/50mA(grid each phase current < 250A).If your local current is big,please buy CT type meter. First model is Eastron SDM630-Modbus V2 which is able to measure the Max. 100A current directly, More details please refer to Pic 7.1 & 7.4. For the Eastron SDM630 MCT 40mA, it needs external CT with a 40mA secondary output current. More details about the Eastron SDM630 MCT, please refer to Pic 7.5 & 7.8. Also, the CHINT meter DTSU666 5(80) A is also supported, it can measure the Max. 80A current directly. More usable models of DTSU666 series , please refer to Pic 7.9-7.16. Suggest purchasing smart meters from authorized distributors of Deye or directly from Deye.

When you are reading this, we believe that you have completed the connection according to the requirements of chapter 5, if you have been running your inverter at this time, and you want to use the zero-export function, please turn off AC and DC switch of the inverter, and wait for 5 minutes until the inverter completely discharged.Please follow below Picture 7.1 to connect the energy meter.

For system wiring diagram, the red line refers to L line (L1, L2, L3), the black line refers to the neutral line (N). Connecting energy meter RS485 cable to inverter's RS485 port. It's recommended to install an AC switch between the inverter and the utility grid, the specs of the AC switch are determined by the power of load.

If there is no integrated DC switch inside the inverter you purchased, we commend you to connect the DC switch. The voltage and current of the switch depend on the PV array you access.

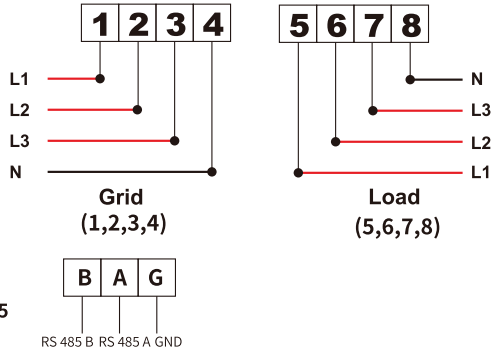

Eastron SDM630-Modbus V2

Pic 7.1 Eastron meter

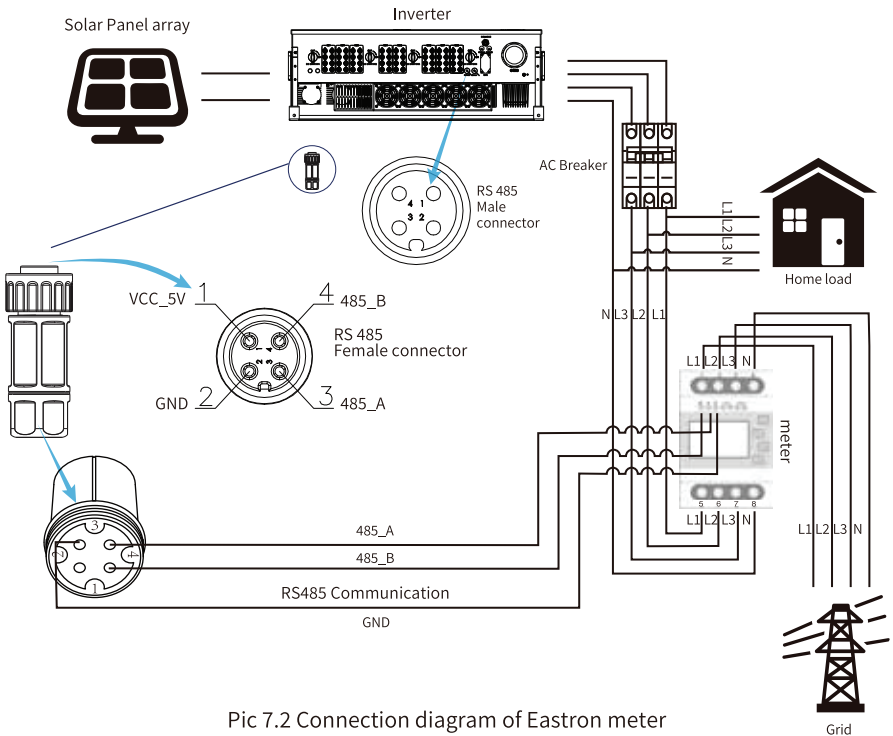

Pic 7.2 Connection diagram of Eastron meter



**Warning:**

In final installation, breaker certified according to IEC 60947-1 and IEC 60947-2 shall be installed with the equipment.

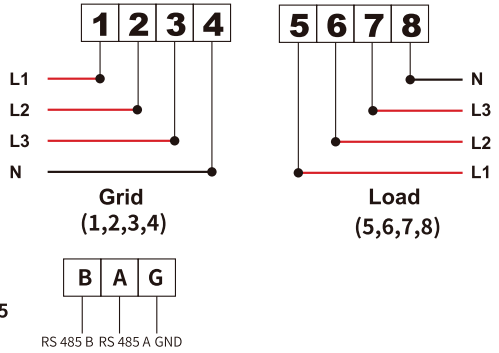

Eastron SDM630-Modbus V2

Pic 7.3 Eastron meter

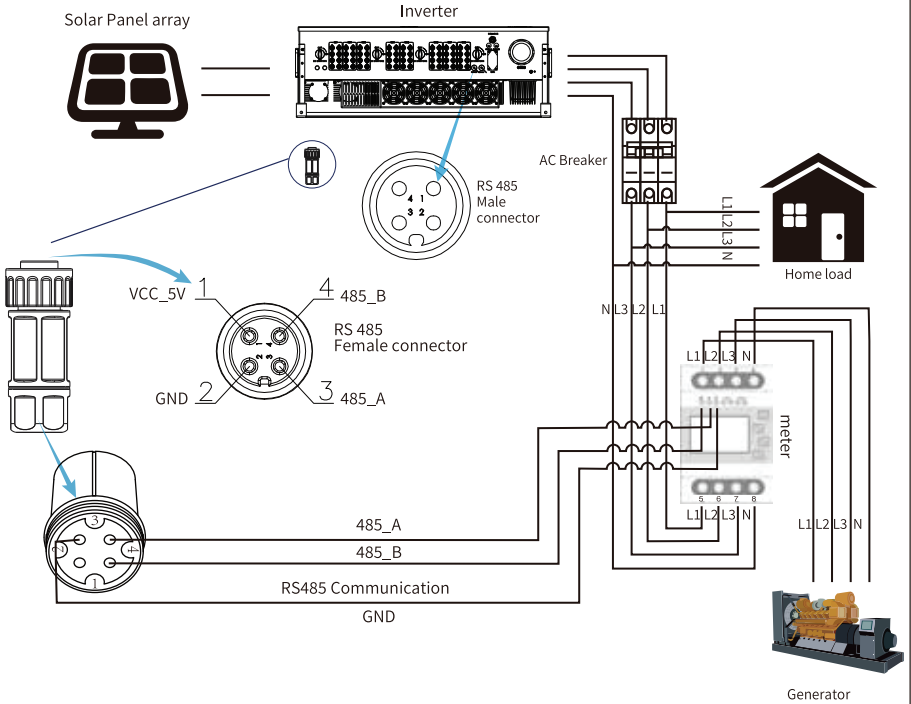

Pic 7.4 Connection diagram of Eastron meter

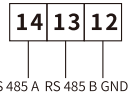
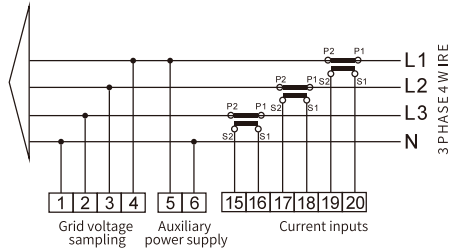
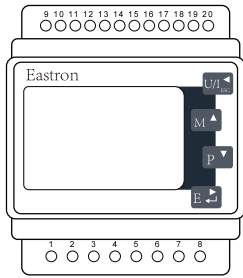

Eastron SDM630MCT

Pic 7.5 Eastron meter

Solar Panel array

Inverter

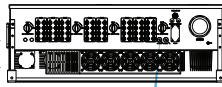

AC Breaker

RS 485 Male connector



Home load

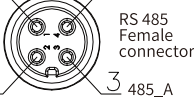

GND

RS 485 Female connector

485\_A

485\_B

RS485 Communication

GND

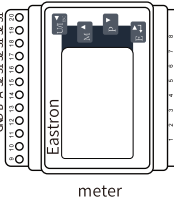

meter

L1 L2 L3 N



Grid

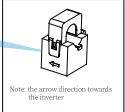

Note: Blue arrow direction towards the inverter

Pic 7.6 Connection diagram of Eastron meter

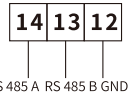
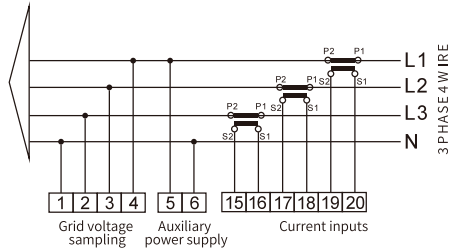
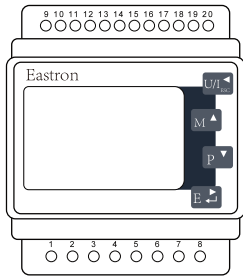

Eastron SDM630MCT

Pic 7.7 Eastron meter

Solar Panel array

Inverter

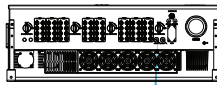

AC Breaker

RS 485 Male connector



Home load

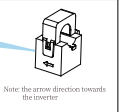
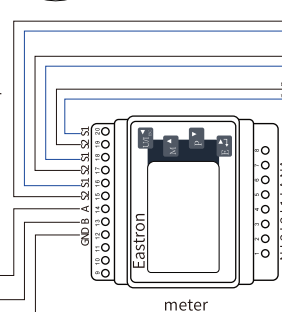
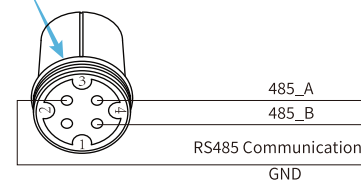
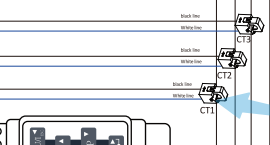
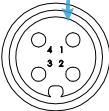
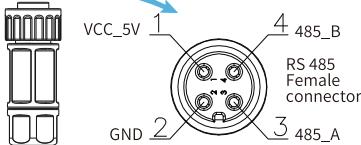

Generator

Pic 7.8 Connection diagram of Eastron meter

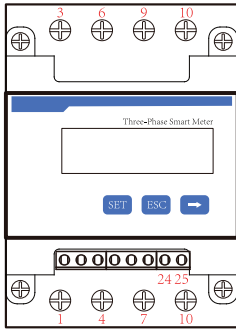

CHINT DTSU666 5(80)A

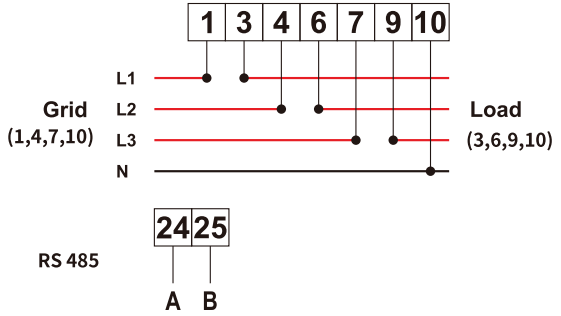

Pic 7.9 CHINT meter

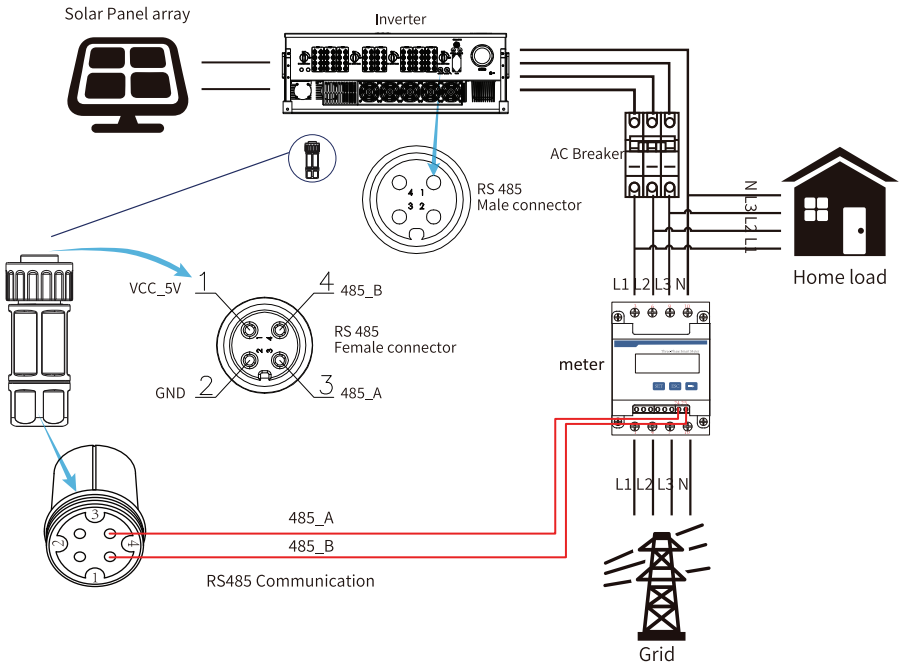

Pic 7.10 Connection diagram of CHINT meter

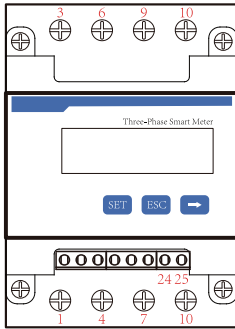

CHINT DTSU666 5(80)A

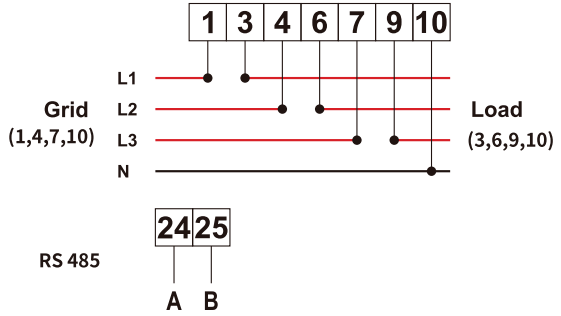

Pic 7.11 CHINT meter

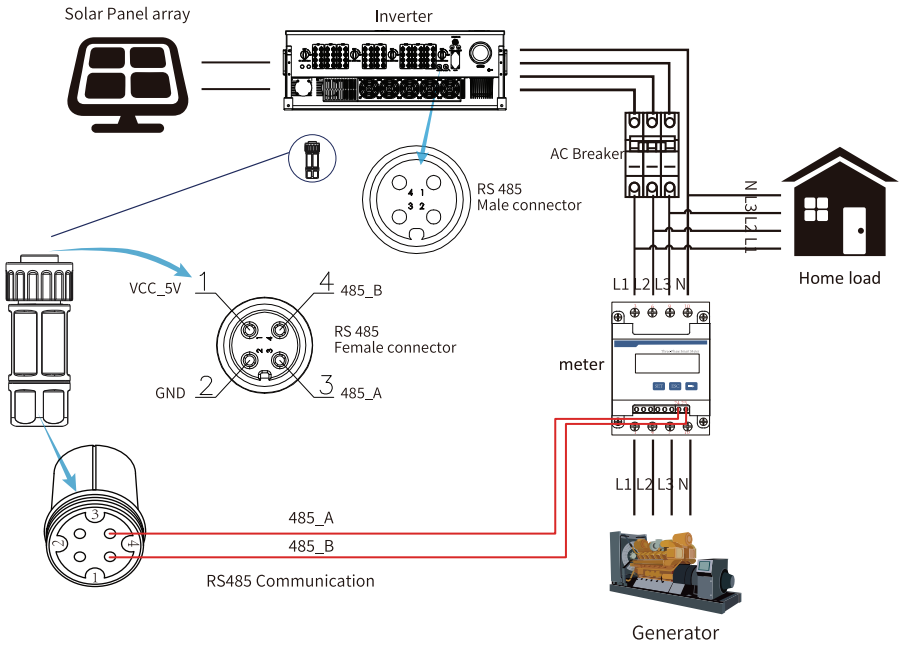

Pic 7.12 Connection diagram of CHINT meter

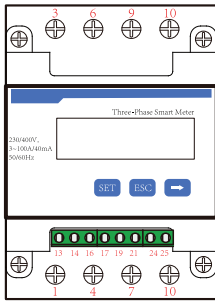

CHINT DTSU666  
3x230/400V  
3~100A/40mA

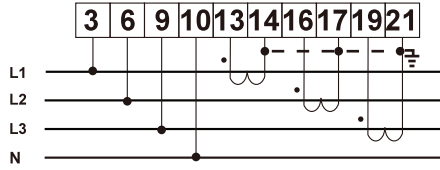

1A 5.000 A

Phase A current =5.000A

1B 5.001 A

Phase B current =5.001A

1C 5.002 A

Phase C current =5.002A

Pic 7.13 CHINT meter

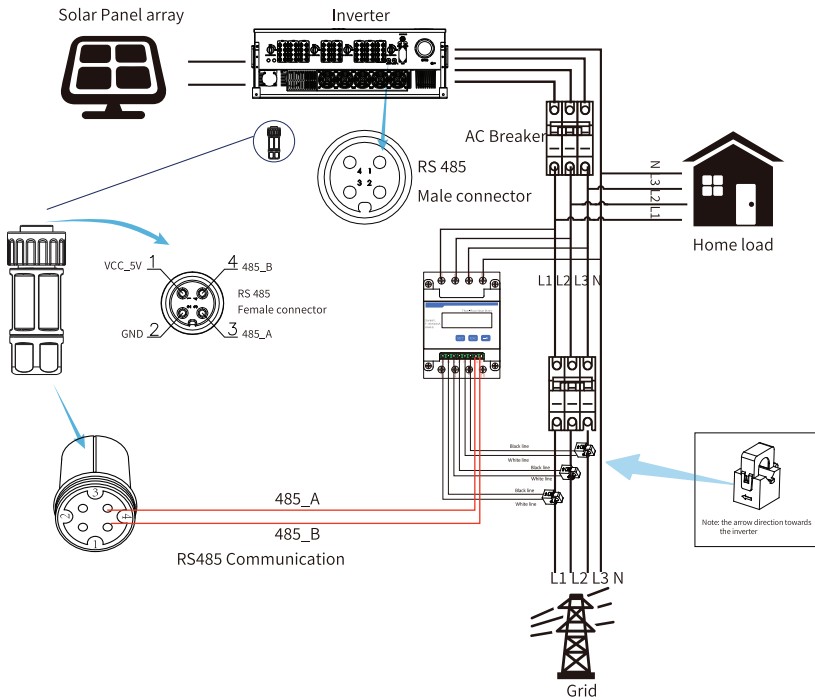

Pic 7.14 Connection diagram of CHINT meter



1. Press Enter button on the LCD panel in the main interface into the menu options, select [parameter setting] to enter setup submenu, and then select [run\_param], at this time please input the default password 1234 through pressing the button [up down, enter], enter the operation parameter setting interface, shown as picture 7.17.

MENU» Setup» Run Param			
ActiveP	31%	SelfCheck	20S
QMode	QU	Island	OFF
ReactP	0.0%	Meter	ON
PF	1.000	Limiter	OFF
Fun_ISO	ON	Feed_In	0%
Fun_RCD	ON	MPPT Num	8
	OK		Cancel

Pic 7.17 Zero-export function via meter setting interface

2. Operate the button [up down], move setting cursor to energy meter and press the button [enter]. At this time you can turn on the energy meter by choosing [up down] button, please press [enter] button to confirm when setting done.
3. Move the cursor to [OK], press [enter] to save the settings and exit the running parameters page, otherwise the settings are invalid.
4. If set up successfully, you can return to the menu interface, and display the LCD to [home page] by press the [up down] button. If it displays [meter power XXW], the zero-export function setting is completed. Shown as picture 7.18.

PARAMETR	Meter
	SN:1
Meter Power:	428W
Load Power:	1.043kW
	Day Total
ImpEp : 9.51kWh	2.24MWh
ExpEp : 0.00kWh	574.75KWh
LoadEp : 13.71kWh	1.67MWh

Pic 7.18 Zero-export function via energy meter turn on

5. Meter power 428W shows positive means grid is supplying the load, and no power fed into grid. if meter power shows negative, it means PV energy is being sold to grid or energy meter wiring connection has problem.
6. After properly connection is done, wait for inverter starting. If the power of the PV array meets the current power consumption, the inverter will keep a certain output to counteract the power of the grid without backflow .

## 7.1 Multiple strings and parallel connection meters

This application is that when the string inverters work in parallel, there is only one power grid and one load, and only one meter can be connected to prevent reverse current, so only this many-to-one anti-reverse current connection can be connected.

If there're several inverters paralleling operation in a plant, also it can use 1pcs meter to realize zero export function. For example, if there're 3pcs inverters paralleling operation in the system with 1pcs meter. We need to setup 1pcs inverter as the master and others setup as slaves. And, all of them need to connect to the meter via RS485. Below is the system diagram and configuration of the system.

MENU Setting			
Exp_Mode	AVG	Generator	ON
CT_Ratio	1	G.CT	1
MFR	AUTO	G.MFR	AUTO
FeedIn	0.0KW	G.Pout	0%
Shunt	OFF	G.Cap	200.0 KW
ShuntQTY	3		
	Back		

Pic 7.19 Meter function

Name	Description	Range
<b>Exp_Mode</b>	AVG: Average power of three phase is zero exported. MIN: Phase with minimum load power is zero exported, while the other two phase may be in purchase mode.	AVG/MIN
<b>CT_Ratio</b>	CT ratio of power grid side meter when extern CT is applied.	1-1000
<b>MFR</b>	Manufacturer of the grid side meter. Modbus Address of it should be set as 01.	AUTO/CHINT/ EASTRON
<b>Feedin</b>	Percentage of the Feed in power exported to the grid.	0-110%
<b>Shunt</b>	Parallel mode. Set one inverter as Master, others are Slave. ONLY need to set the master, Slave will follow the settings in the master.	OFF/Master/ Slave
<b>ShuntQTY</b>	Number of inverters in parallel	1-16
<b>Generator</b>	DG side meter function Enable/Disable	ON/OFF
<b>G.CT</b>	CT ratio of power DG side meter when extern CT is applied.	1-1000
<b>G.MFR</b>	Manufacturer of the DG side meter. Modbus Address of it should be set as 02.	AUTO/CHINT/ EASTRON
<b>G.Pout</b>	Output power percentage of the DG.	0-110%
<b>G.Cap</b>	Capacity of the DG.	1-999kW

**Note:** Select Meter option in Run Param and long press ENTER button to enter this Meter Setting page.



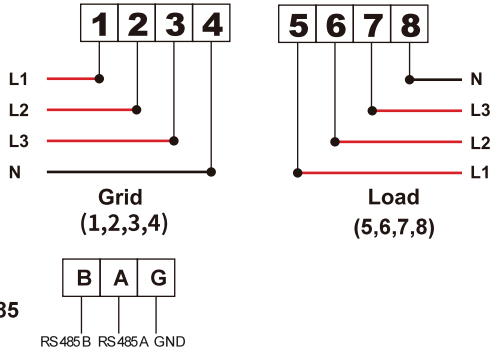

Eastron SDM630-Modbus V2 Pic 7.22 Eastron meter

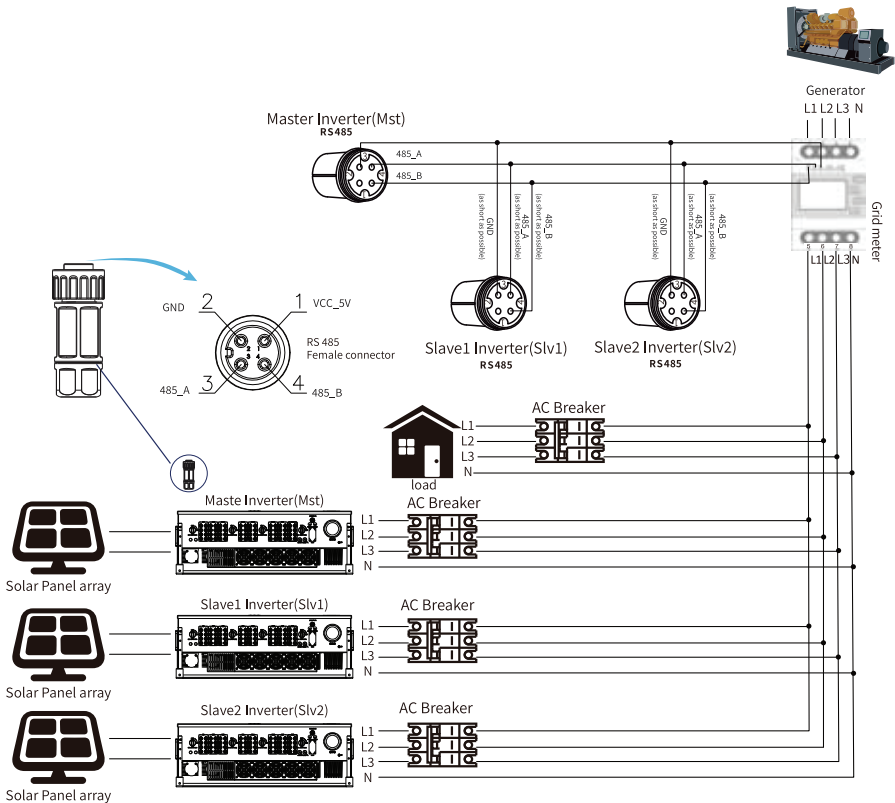

Pic 7.23 Eastron Connection diagram(The pass-through table)

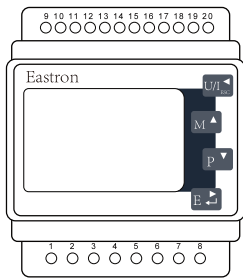

Eastron SDM630MCT

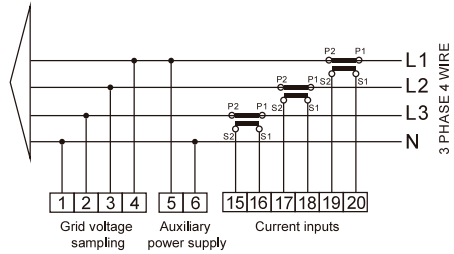

RS 485

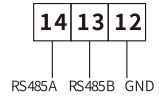

Pic 7.24 Eastron meter

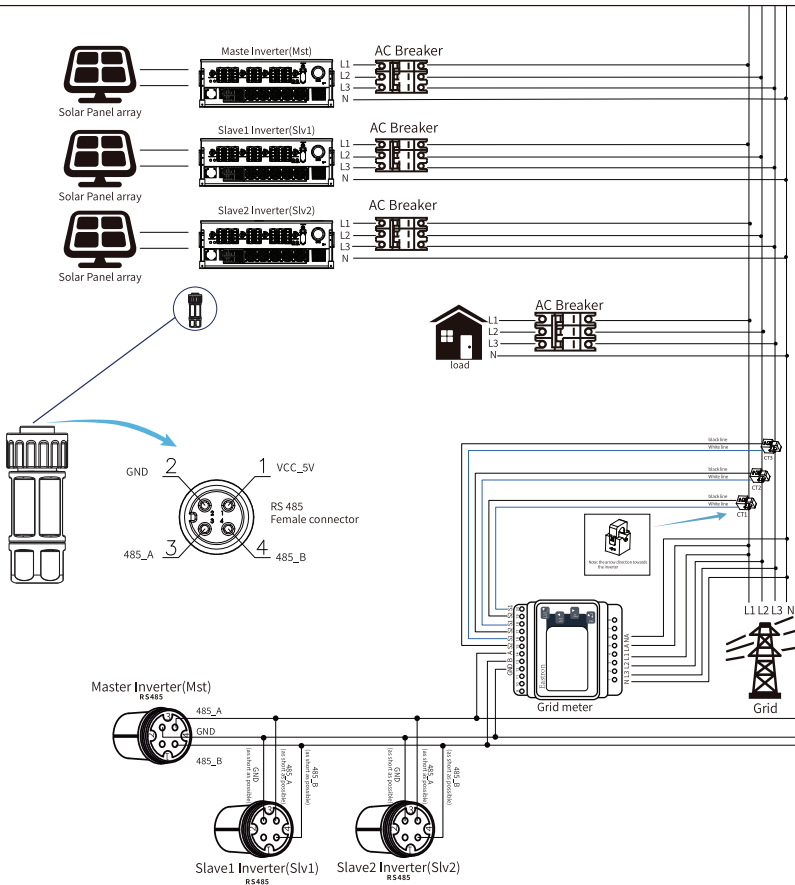

Pic 7.25 Connection diagram(Three-phase electricity)

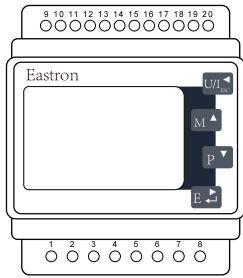

Eastron SDM630MCT

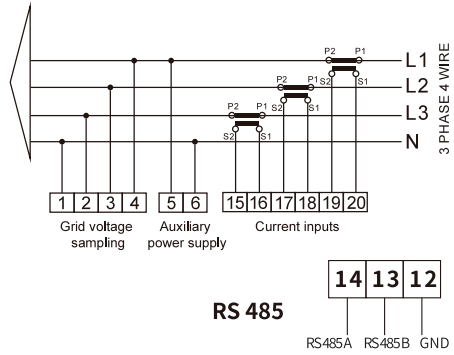

Pic 7.26 Eastron meter

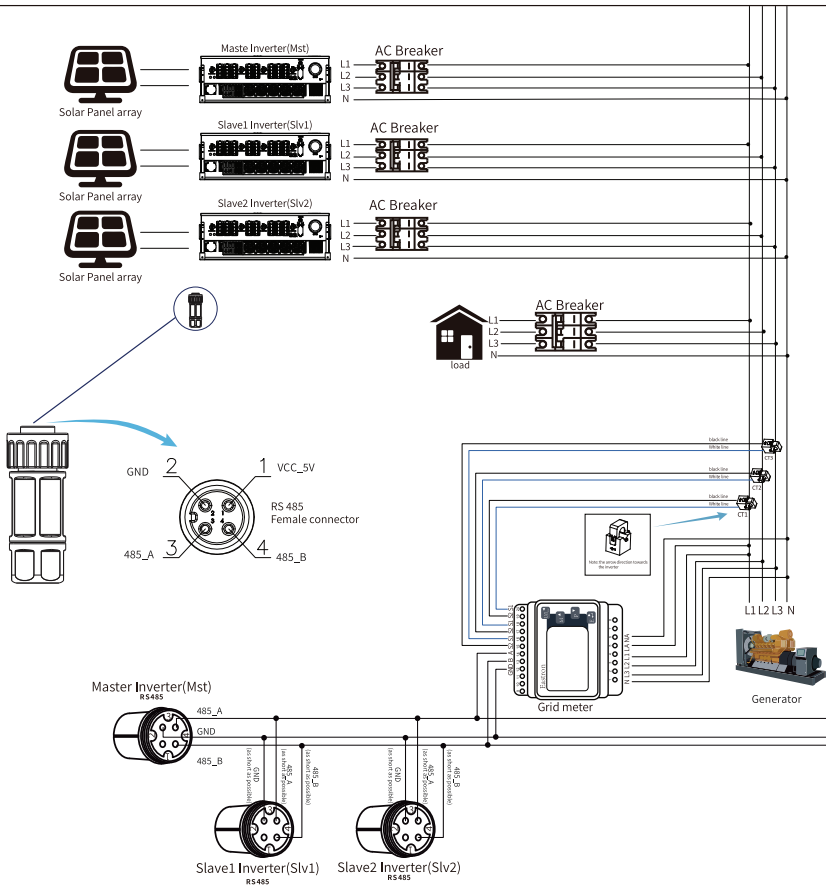

Pic 7.27 Connection diagram(Three-phase electricity)

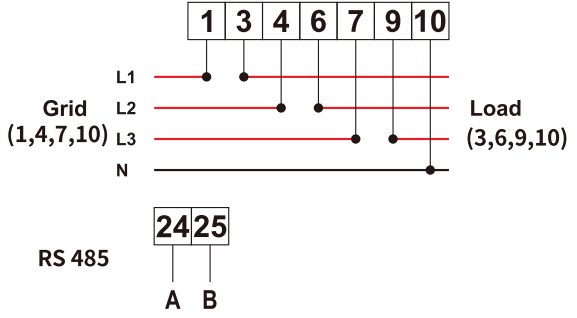
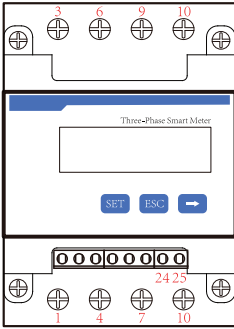

CHINT DTSU666 5(80)A

Pic 7.28 CHINT meter

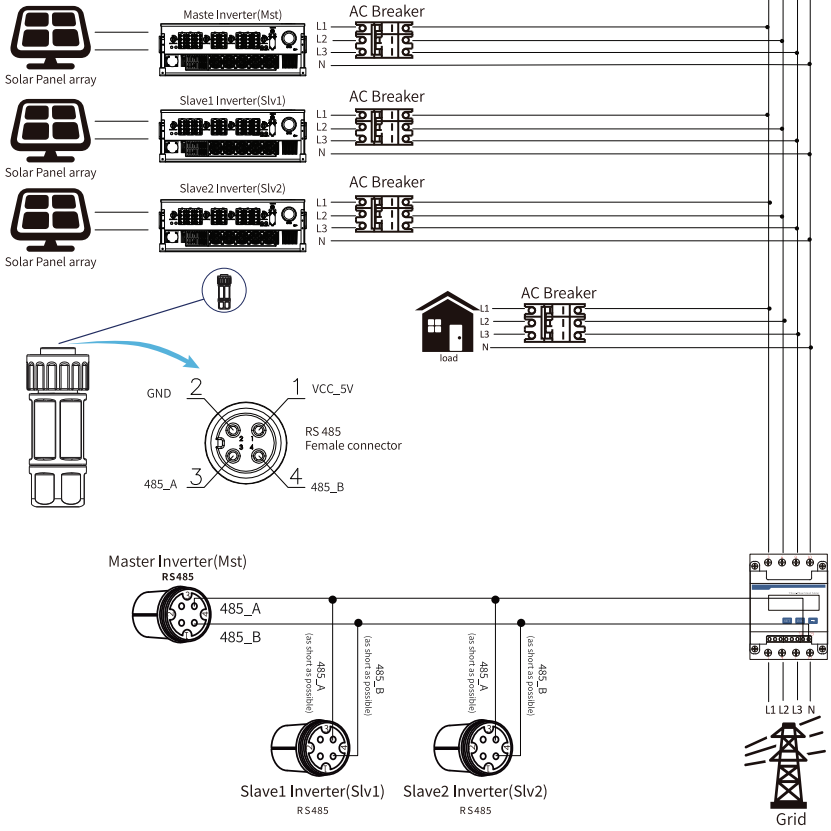

Pic 7.29 CHINT Connection diagram(The pass-through table)

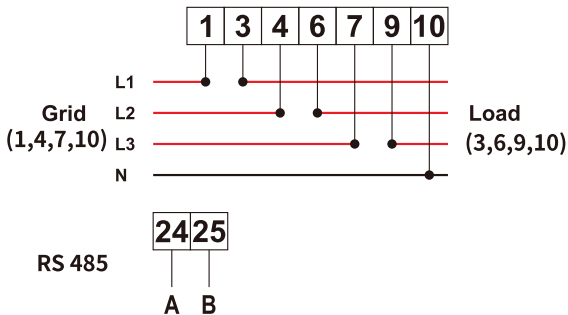
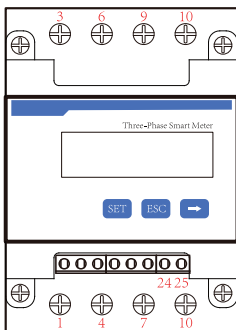

CHINT DTSU666 5(80)A

Pic 7.30 CHINT meter

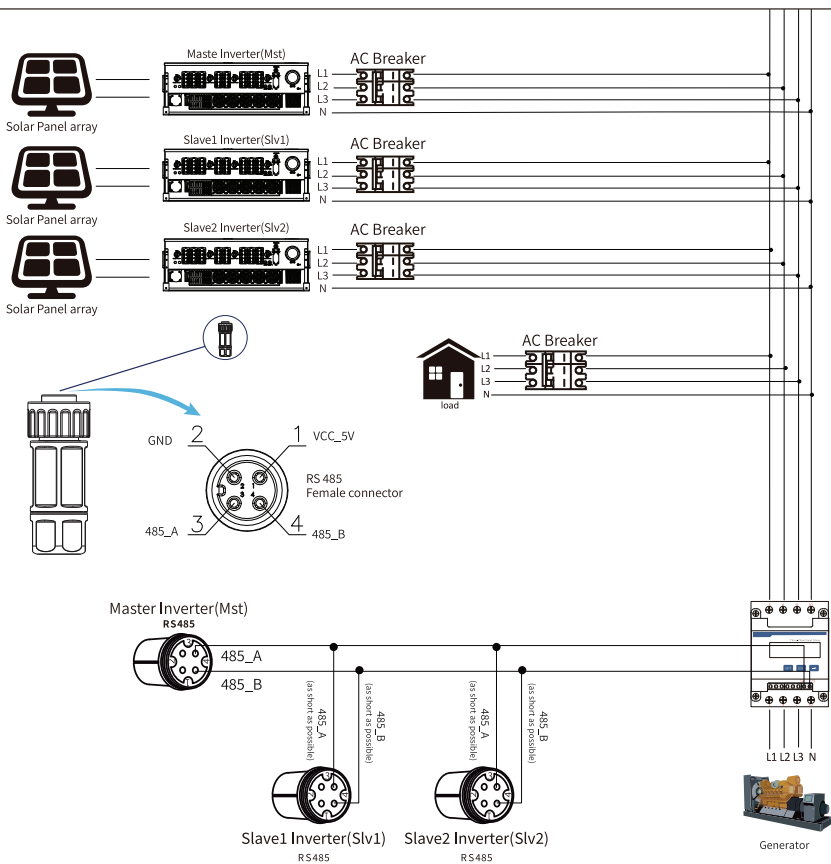

Pic 7.31 CHINT Connection diagram(The pass-through table)



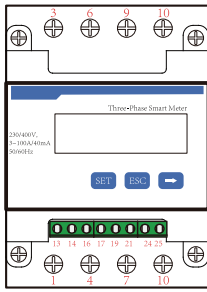

CHINT DTSU666  
3x230/400V  
3~100A/40mA

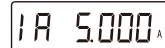
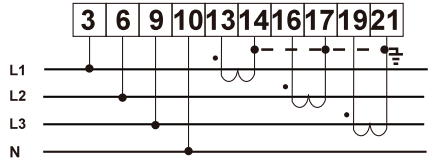

Phase A current =5.000A



Phase B current =5.001A



Phase C current =5.002A

Pic 7.34 CHINT meter

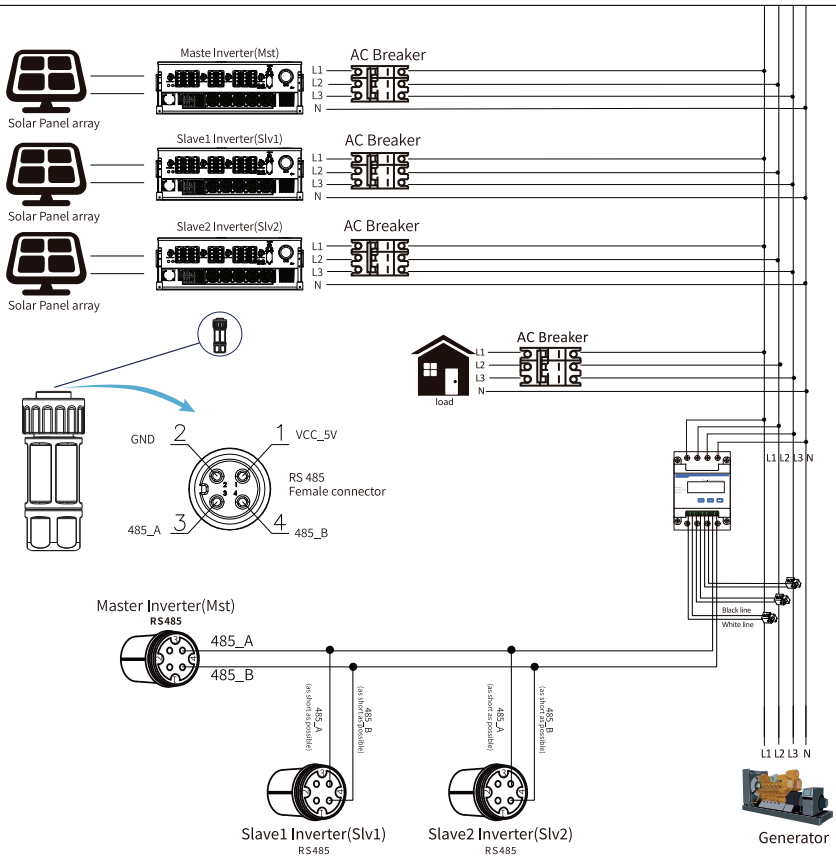

Pic 7.35 CHINT Connection diagram(The pass-through table)

## 7.2 How to browse the load power of your PV grid-tie plant on monitoring platform?

If you want to browse load power of the system and how much energy (KWH) does it export to grid (inverter output power is used to power the load firstly and then the surplus energy will feed into grid). You also need to connect the meter according to above diagram. After the connection completed successfully, the inverter will show the load power on the LCD. **But please don't setup "Meter ON"** . Also, you will be able to browse the load power on the monitoring platform. The plant setting method as below description.

Firstly, go to the solarman platform(<https://pro.solarmanpv.com>, this link is for solarman distributor account; or <https://home.solarmanpv.com>, this link is for solarman end user account;) plant home page and click "edit"

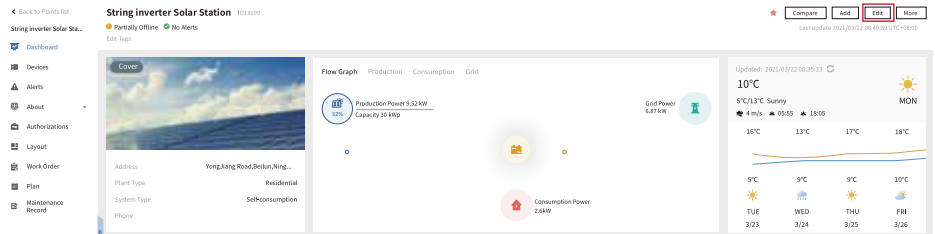

And then choose your system type as "Self-consumption"

The 'Edit Plant' page is divided into several sections: 'Basic Info' (Address: YongKang Road, Beikun, Beijing, 315906, China), 'System Info' (Coordinates: 121° 46' 19.03" Longitude, 29° 53' 36.11" Latitude), 'Owner Info' (Time Zone: [UTC+08:00] Beijing, Chongqing, Hong Kong, Urumqi; Creation Time: 2020/04/08), and 'System Info' (Plant Type: Residential, System Type: Self-consumption, Capacity (kWp): 30, Address: 0-000). The 'System Type' dropdown menu is highlighted with a red box, showing 'Self-consumption' as the selected option.

Secondly, go to plant page, if it shows the PV power, load power and grid power, which means the configuration is correct.

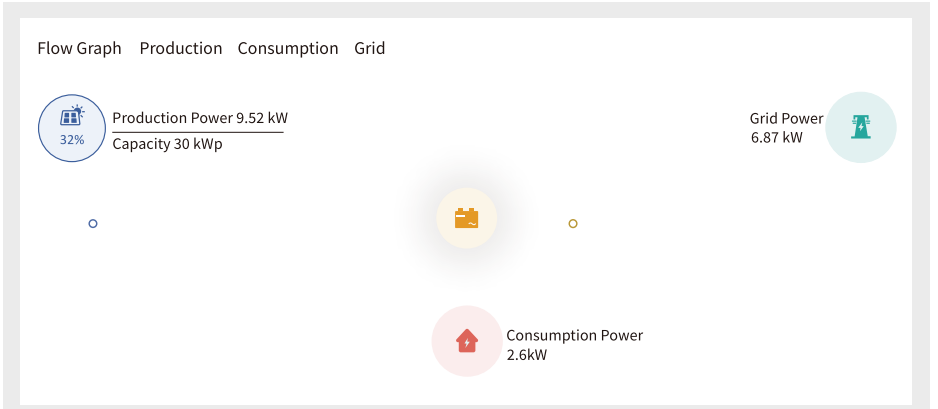
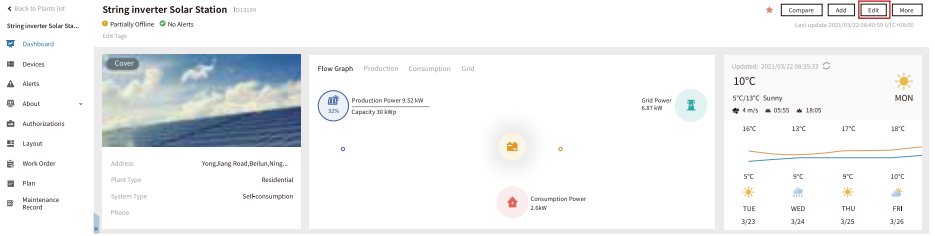

## 8. General Operation

During normal operation, the LCD shows the current status of the inverter, including the current power, total generation, a bar chart of power operation and inverter ID, etc. Press the Up key and the Down key to see the current DC voltage, DC current, AC voltage, AC current, inverter radiator temperature, software version number and Wifi connection state of the inverter.

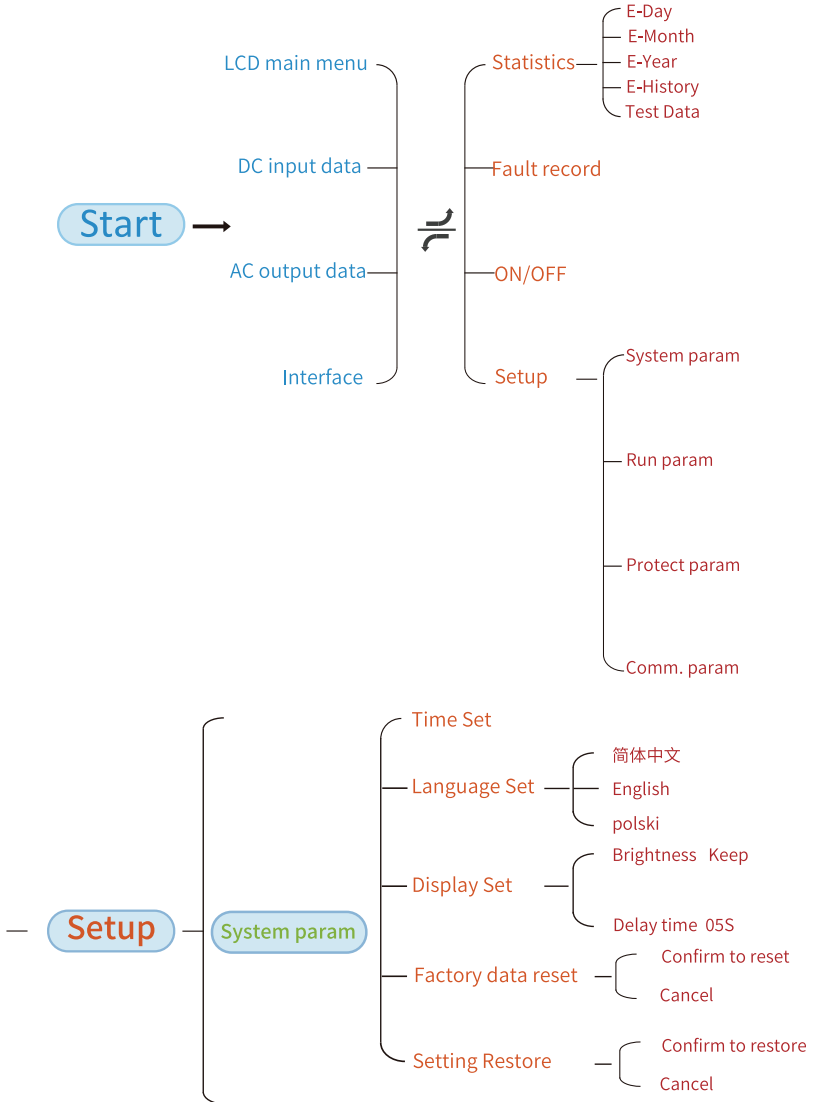

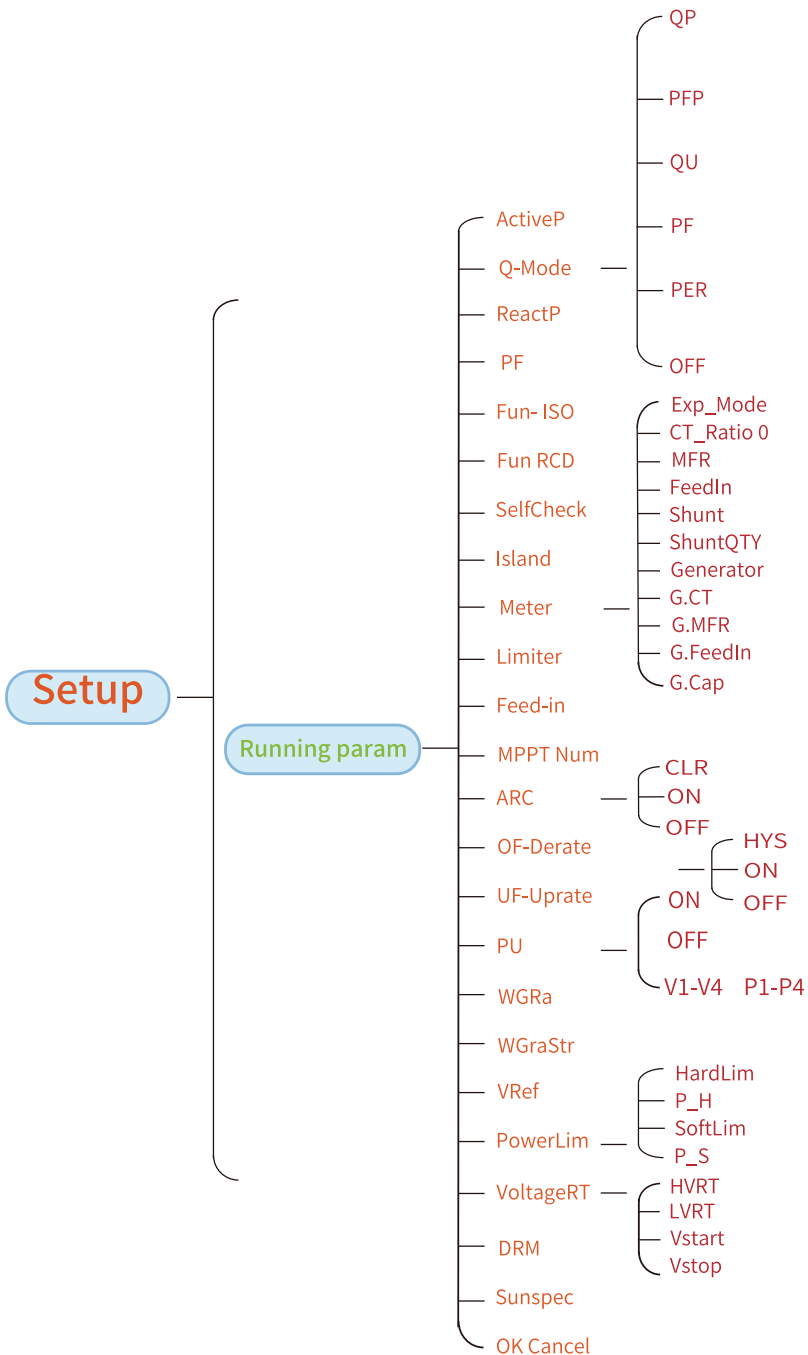

**\*Note: These parameters will be available after the meter is connected successfully. Otherwise, it won't show.**

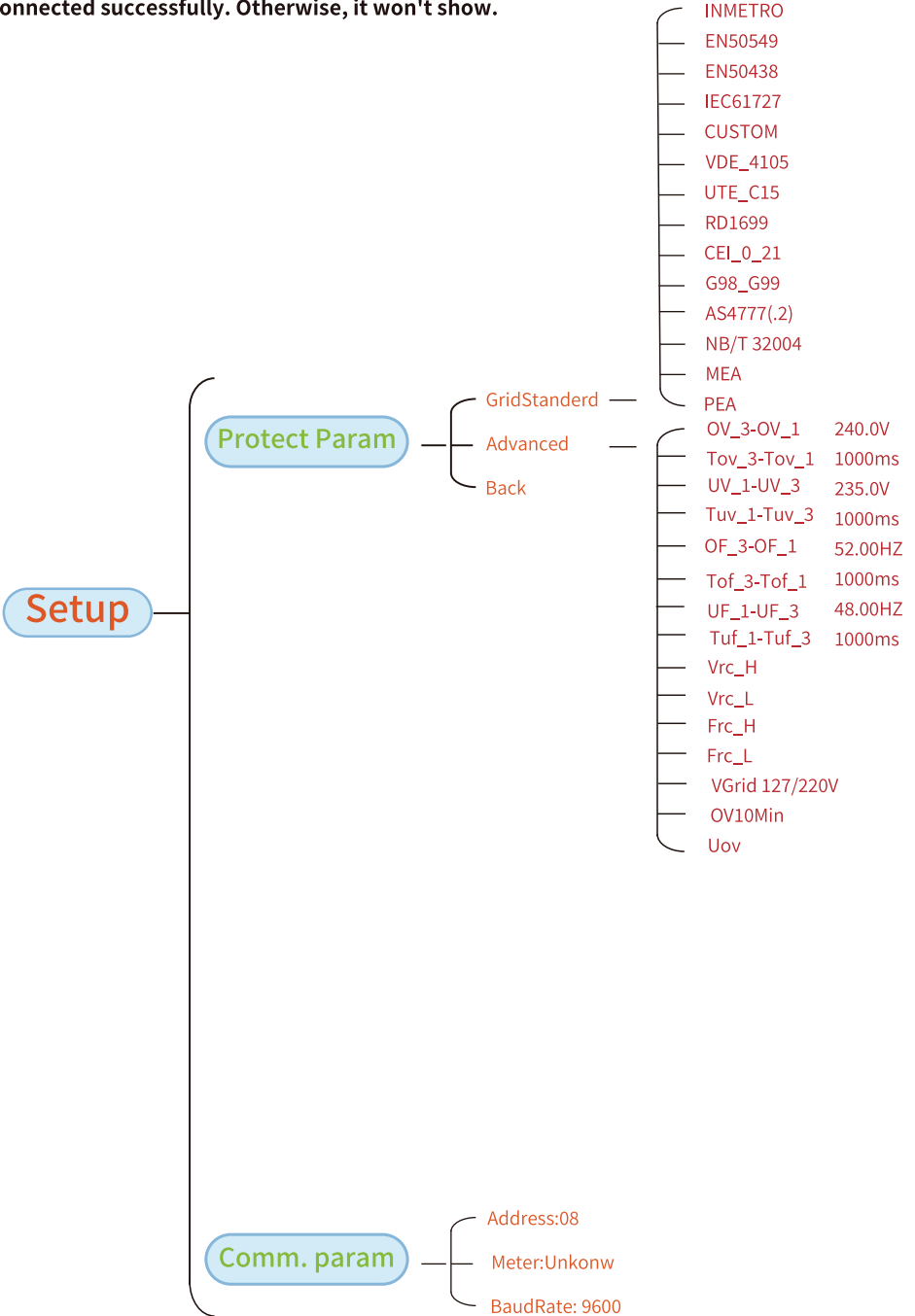

## 8.1 The initial interface

From the initial interface, you can check power, daily generation, gross generation, invertert ID , model and time.

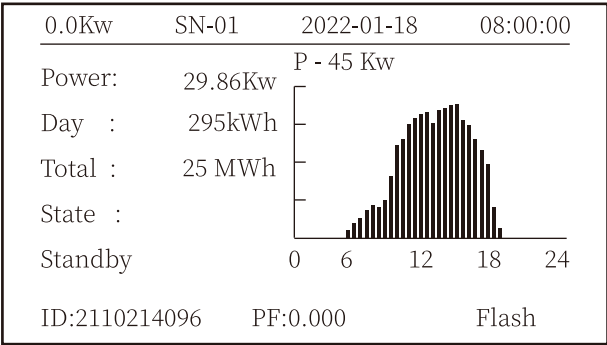

Pic 8.1 The initial interface

Press UP or Down you can check inverter DC voltage, DC current, AC voltage, AC current, inverter temperature, software version information.

RUN	Input		
PV1	V : 349.9V	I : 10.3A	P : 3.6KW
PV2	V : 313.0V	I : 8.3A	P : 2.6KW

Pic 8.2 PV input and DC current information

You can check the PV information, the number of strings input, MPPT voltage and MPPT current.

<u>RUN</u>	<u>Grid</u>
Ua : 234.5V	Ia : 0.0A
Grid Freq : 50.00Hz	
PF : 0.000	

Pic 8.3 AC running state information

You can check the three phase voltage, current, and grid frequency.

<u>RUN</u>
Total DC Power:
3.602W
Lcd0196 Inv1400
● ●

Pic 8.4 Inverter firmware version

You can check the inverter LCD software Ver0196 and Control Software Version Ver1400. There are two black spot in the bottom right corner. The first flash means inverter is communicating with LCD. The second flash means LCD is communicating with wifi plug.

<u>PARAMETR</u>	<u>Meter</u>
	SN: 0
Meter Power: 0W	
Load Power: 0W	
Day	Total
ImpEp : 0.00kWh	0.00kWh
ExpEp : 0.00kWh	0.00kWh
LoadEp : 0.00kWh	0.00kWh

Pic 8.5 Meter power and load power

### 8.1.1 Main Menu

There are four submenu in the Main Menu.

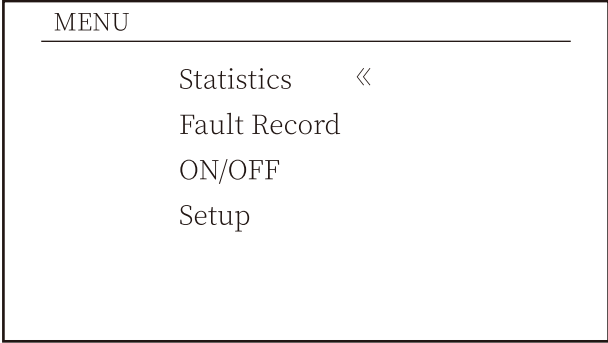

Pic 8.6 Main Menu

### 8.2 Statistics information

There are five submenu in the statistics.

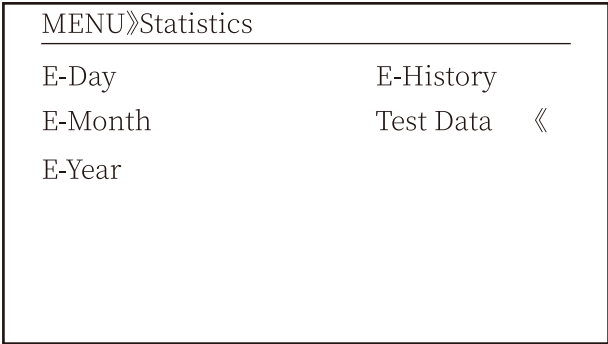

Pic 8.7 Statistics

Into each submenu through cursor.

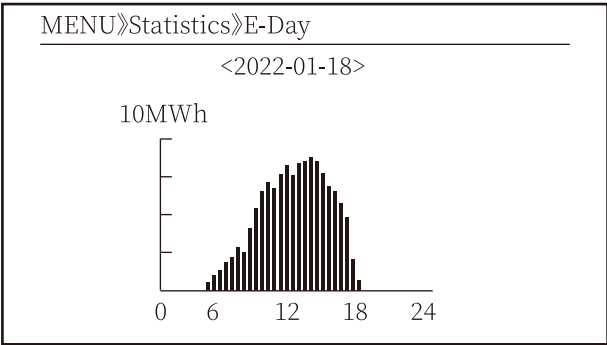

Pic 8.8 E-Day

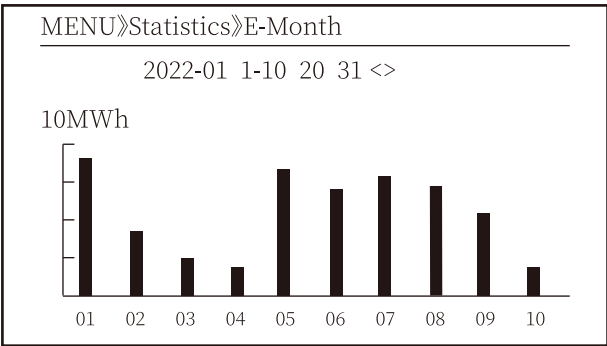

Pic 8.9 E-Month

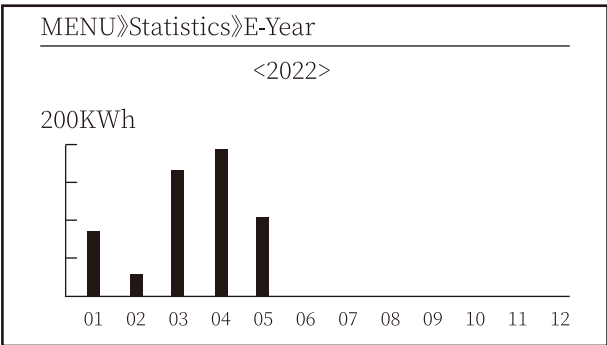

Pic 8.10 E-Year

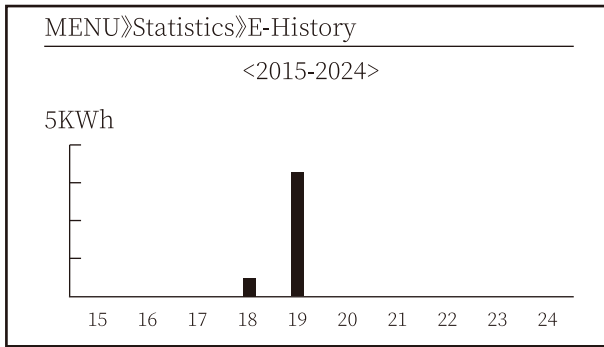

Pic 8.11 E-History

This information is for technician's reference.

PV1 :	19186	1k3 :	11126	ofC :	2057
PV2 :	19198	1k4 :	11140	137 :	2145
HV :	24362	1k5 :	16666	138 :	2248
GFD :	9119	1k6 :	2927	139 :	1497
DiL :	36	vHV :	24362	140 :	0
AVL :	-2	BSn :	12218	141 :	0
126 :	287	ofA :	2065	142 :	0
1k2 :	6	ofB :	2653	143 :	0
146 :	0	148 :	0	144 :	0
147 :	0	149 :	0	145 :	0

Pic 8.12 Test Data

### 8.3 Fault Record

Only can keep four fault record in the menu include time, customer can deal with it depends on the error code.

MENU»Fault Record

Fault :	F352022-01-05 08:38
History : 1	F352022-01-05 08:37
2	F352022-01-04 18:47
3	F352022-01-04 17:54
4	F352022-01-04 17:53

Pic 8.13 Fault Record

## 8.4 ON/OFF setting

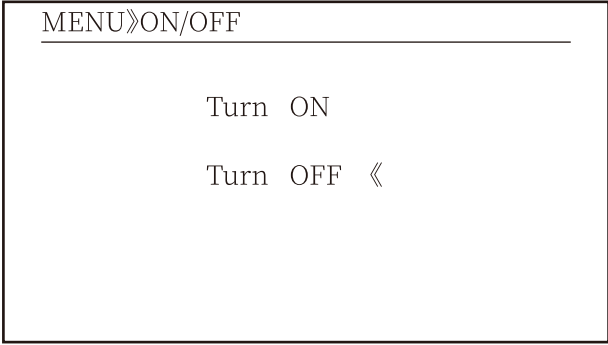

Pic 8.14 ON/OFF setting

Into each submenu through cursor.

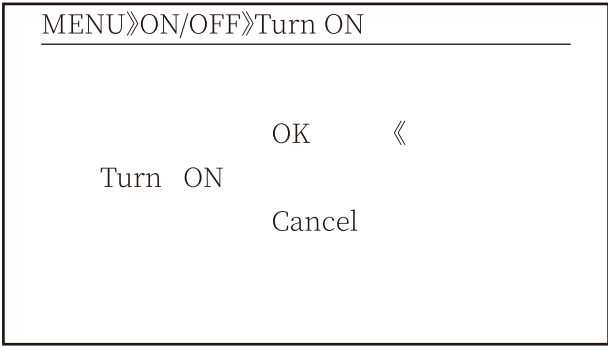

Pic 8.15 ON set

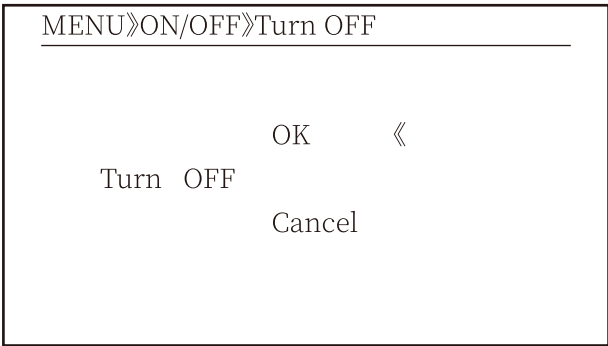

Pic 8.16 OFF set

## 8.5 Parameter setting

Setting includes system param, run param, protect param, comm.. param. All of these information for maintenance reference.

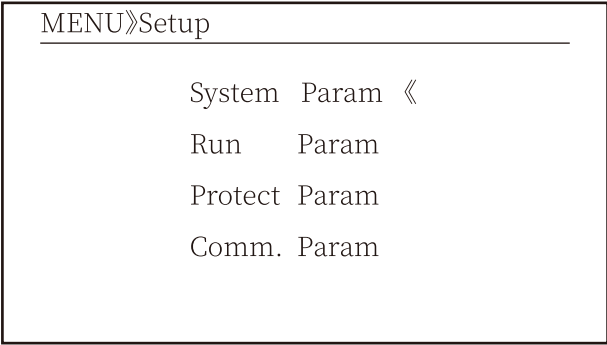

Pic 8.17 Setting

### 8.5.1 System Param

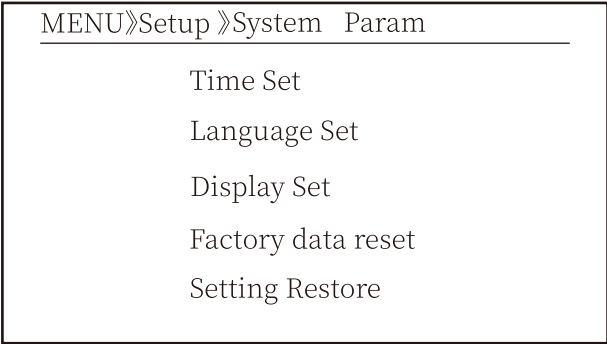

Pic 8.17.1 System Param Setting

**8.5.1.1 Time Set**

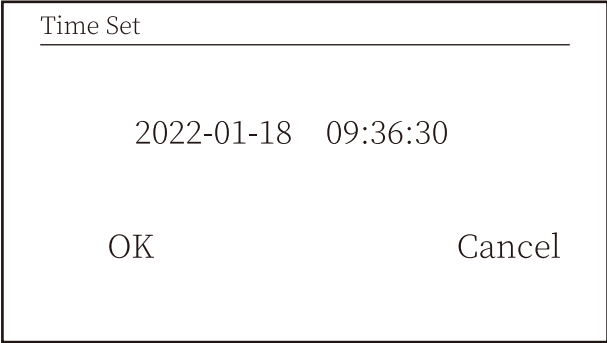

Pic 8.18 System Param

**8.5.1.2 Language Set**



Pic 8.19 Language set

**8.5.1.3 Display Set**

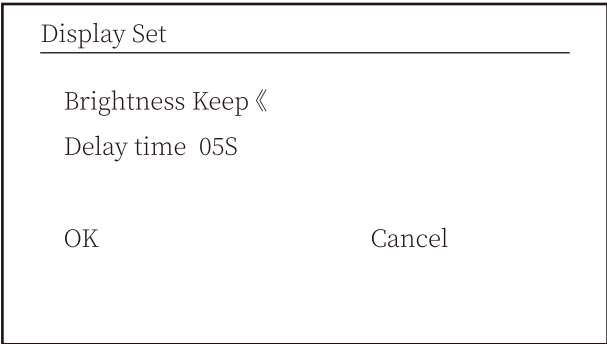

Pic 8.20 Display set

### 8.5.1.4 Factory data reset

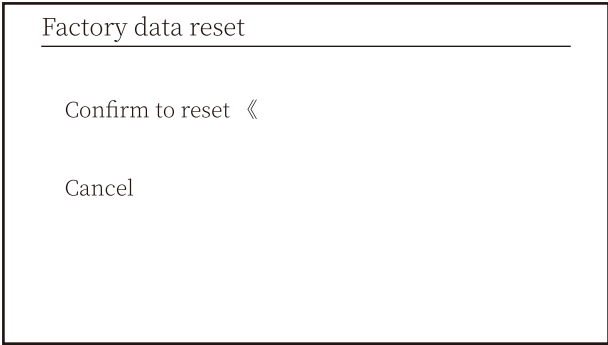

Pic 8.21 Factory data reset set

### 8.5.1.5 Setting Restore

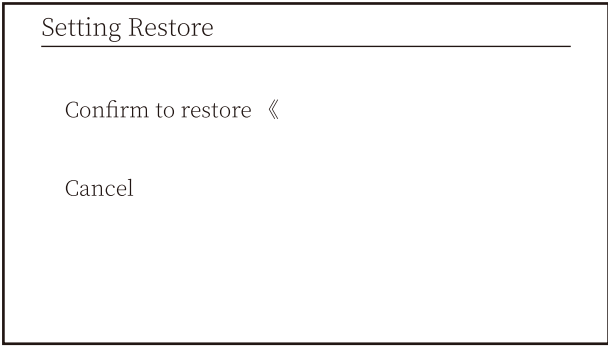

Pic 8.22 Factory data reset set



**Warning:** Password required-- only for access-authorized engineer. Un-authorized access may avoid the warranty. The initial password is 1234.

## 8.5.2 Protect Param

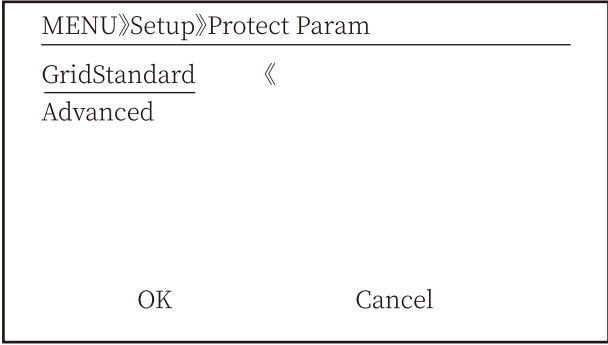

Pic 8.23 Protect Param



**Warning:**  
Engineer only.

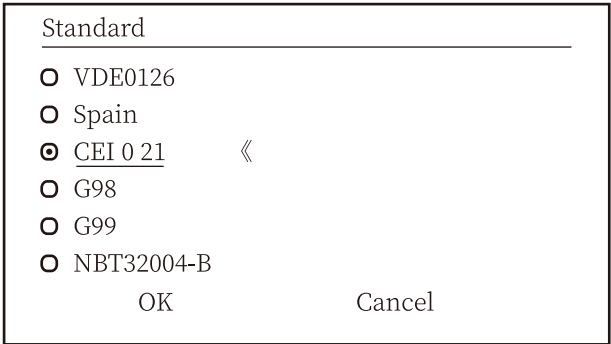
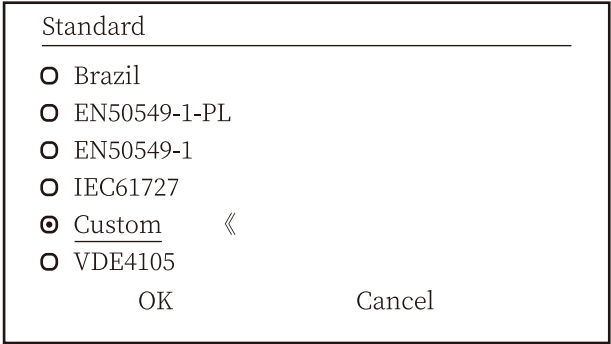

Standard

---

- Australia-A
- Australia-B
- Australia-C 《
- New Zealand
- MEA
- PEA

OK                      Cancel

Standard

---

- Norway
- Switerland
- R25 《
- CEI-016

OK                      Cancel

Pic 8.24 "Standard"

- VoltageTriping

---

OV_3	240.0V	Tov_3	1000ms
OV_2	240.0V	Tov_2	1000ms
OV_1	240.0V	Tov_1	1000ms
UV_1	240.0V	Tuv_1	1000ms
UV_2	240.0V	Tuv_2	1000ms
UV_3	240.0V	Tuv_3	1000ms

OK                      Cancel

- Frequency Tripping			
OF_3	52.00Hz	Tof_3	1000ms
OF_2	52.00Hz	Tof_2	1000ms
OF_1	52.00Hz	Tof_1	1000ms
UF_1	48.00Hz	Tuf_1	1000ms
UF_2	48.00Hz	Tuf_2	1000ms
UF_3	48.00Hz	Tuf_3	1000ms
OK		Cancel	

- Miscellaneous			
Vrc_H	0.0V	Uov	0.0%
Vrc_L	0.0V		
Frc_H	0.0Hz		
Frc_L	0.0Hz		
VGrid	127/220V		
OV10Min	OFF		
OK		Cancel	

Pic 8.25 “Advanced”

### 8.5.3 Comm. Param

MENU»Setup»Comm.Param	
WIFI-SET	485-SET
Address : 01	« Address : 01
	Func : 485
	Baud : 9600

Pic 8.26 Communication param

## 9. Repair and Maintenance

String type inverter doesn't need regular maintenance. However, debris or dust will affect heat sink's thermal performance. It is better to clean it with a soft brush. If the surface is too dirty and affect the reading of LCD and LED lamp, you can use wet cloth to clean it up.



### High Temperature Hazard:

When the device is running, the local temperature is too high and the touch can cause burns. Turn off the inverter and wait for it cooling, then you can clean and maintain.



### Safety Hint:

No solvent, abrasive materials or corrosive materials can be used for cleaning any parts of the inverter.

## 10. Error information and processing

Inverter has been designed in accordance with international grid tied standards for safety, and electromagnetic compatibility requirements. Before delivering to the customer the inverter has been subjected to several tests to ensure its optimal operation and reliability.

### 10.1 Error code

If there is any failure, the LCD screen will display an alarm message. In this case, the inverter may stop feeding energy into the grid. The alarm description and their corresponding alarm messages are listed Table 10.1.

Error code	Description	Ongrid - Three Phase
W03	Arc warning	Arc error indicates that the PV side of the inverter has caused an arc issue. It is necessary to check the connection of the PV and then clear this fault through the ARC function in the operating parameters, then it can resume operation.
W05	Upgrade error warning	Firmware was upgraded incorrectly. Please upgrade to the correct firmware.
W13	Fan warning	Usually, due to one or more fan cables are not properly connected or fan is broken, the solution is to check whether all fan cables are properly connected or not, or replace the faulty fan.
W15	Prefix error	Version upgrade error, need to contact after-sales engineer to send command to fix.

Error code	Description	Ongrid - Three Phase
F01	DC input polarity reverse fault	Check the PV input polarity.
F02	DC insulation impedance permanent fault	Check the grounding cable of inverter.
F03	DC leakage current fault	Restart the inverter, if not ruled out, try contacting the installer /manufacturer customer service
F04	Ground fault GFDI	Check the solar panel output connection.
F05	Read the memory error	Failure in reading memory (EEPROM). Restart the inverter if the fault still exists, contact your installer.
F06	Write the memory error	Failure in writing memory (EEPROM). Restart the inverter if the fault still exists, contact your installer.
F07	GFDI blown fuse	Restart the inverter, if not ruled out, try contacting the installer /manufacturer customer service
F08	GFDI grounding touch failure	Restart the inverter, if not ruled out, try contacting the installer /manufacturer customer service
F09	IGBT damaged by excessive drop voltage	Restart the inverter, if not ruled out, try contacting the installer /manufacturer customer service
F10	Auxiliary switch power supply failure	1. It tells the DC 12V is not existed. 2. Restart the inverter, if the fault still exists, please contact your installer.
F11	AC main contactor errors	Restart the inverter, if not ruled out, try contacting the installer /manufacturer customer service
F12	AC auxiliary contactor errors	Restart the inverter, if not ruled out, try contacting the installer /manufacturer customer service
F13	reserved	1. Loss of one phase or AC voltage detection part failure or relays not closed. 2. Restart the inverter, if the error still exists, please contact your installer .
F14	DC firmware over current	Restart the inverter, if not ruled out, try contacting the installer /manufacturer customer service
F15	AC firmware over current	1. The internal AC sensor or detection circuit on control board or connection wire may loose. 2. Restart the inverter, if the error still exists, please contact your installer.
F16	GFCI(RCD) Ac leakage current fault	1. This fault means the average leakage current is over 300mA. Check whether DC power supply or solar panels is ok, then check 'Test data'-> 'diL' value is about 40; Then check the leakage current sensor or circuit (the following picture). Checking test data needs using big LCD. 2. Restart the inverter, if the error still exists, please contact your installer.
F17	Three phase current, over-current fault	Restart the inverter, if not ruled out, try contacting the installer /manufacturer customer service
F18	AC over current fault of hardware	1. Check AC sensor or detection circuit on control board or connection wire. 2. Restart the inverter or factory reset, if the error still exists, please contact your installer.
F19	All hardware failure synthesis	Restart the inverter, if not ruled out, try contacting the installer /manufacturer customer service
F20	DC over current fault of the hardware	1. Check whether solar panel output current is within the allowed range. 2. Check DC current sensor and its detection circuit. 3. Check if the inverter FW version is suitable for the hardware. 4. Restart the inverter, if the error still exists, please contact your installer.

Error code	Description	Ongrid - Three Phase
F21	DC leakage flow fault	Restart the inverter, if not ruled out, try contacting the installer /manufacturer customer service
F22	Crash stop (if there is a stop button)	Contact your installer for help.
F23	AC leakage current is transient over current	1. This fault means the leakage current is above 30mA suddenly. Check whether DC power supply or solar panels is ok, then check 'Test data'-> 'dIL' value is about 40; Then check the leakage current sensor or circuit. Check test data needs using big LCD. 2. Restart the inverter, if the fault still exists, contact your installer.
F24	DC insulation impedance failure	1. Check Vpe resistance on main board or detection on control board. Check PV panels is OK. Many times this issue is the PV problem. 2. Check whether the PV panel (aluminum frame) is grounded well and inverter is grounded well. Open the cover of inverter and then check the inside ground cable is fixed well on the shell. 3. Check if the AC/DC cable, terminal block are shorted to ground or the insulation is damaged. 4. Restart the inverter, if the fault still exists, contact your installer.
F25	DC feedback fault	Restart the inverter, if not ruled out, try contacting the installer /manufacturer customer service
F26	The DC busbar is unbalanced	1. Check whether the 'BUSN' cable or driver board power supply cable is loose. 2. Restart the inverter, if the fault still exists, contact your installer.
F27	DC end insulation error	Restart the inverter, if not ruled out, try contacting the installer /manufacturer customer service
F28	Inverter 1 DC high fault	Restart the inverter, if not ruled out, try contacting the installer /manufacturer customer service
F29	AC load switch failure	Restart the inverter, if not ruled out, try contacting the installer /manufacturer customer service
F30	AC main contactor failure	1. Check relays and AC voltage of relays. 2. Check relays driver circuit. Check if the software is not suitable for this inverter. (Old inverter not have relays detection function) 3. Restart the inverter, if the fault still exists, contact your installer.
F31	Relay open circuit fault	1. At least one Relay can't be closed. Check relays and its driver signal. (Old inverter not have relays detection function) 2. Restart the inverter, if the fault still exists, contact your installer.
F32	Inverter 2 dc high fault	Restart the inverter, if not ruled out, try contacting the installer /manufacturer customer service
F33	AC over current	Restart the inverter, if not ruled out, try contacting the installer /manufacturer customer service
F34	AC current over load	Restart the inverter, if not ruled out, try contacting the installer /manufacturer customer service
F35	No AC grid	1. Check AC grid voltage. Check AC voltage detection circuit. Check if the AC connector in good condition. Check whether the AC grid is normal in voltage. 2. Restart the inverter, if the fault still exists, contact your installer.
F36	AC grid phase error	Restart the inverter, if not ruled out, try contacting the installer /manufacturer customer service
F37	AC three-phase voltage unbalance failure	Restart the inverter, if not ruled out, try contacting the installer /manufacturer customer service
F38	AC three-phase current unbalance failure	Restart the inverter, if not ruled out, try contacting the installer /manufacturer customer service

Error code	Description	Ongrid - Three Phase
F39	AC over current(one cycle)	1. Check AC current sensor and its circuit. 2. Restart the inverter, if the fault still exists, contact your installer.
F40	DC over current	Restart the inverter, if not ruled out, try contacting the installer /manufacturer customer service
F41	AC Line W,U over voltage	Check the AC voltage protection setting. And Check if the AC cable is too thin.Check the voltage difference between LCD and meter.
F42	AC Line W,U low voltage	Check the AC voltage protection setting. Check the voltage difference between LCD and meter. Also need to check whether AC cables are all firmly and correctly connected.
F43	AC Line V,W over voltage	Check the AC voltage protection setting.And Check if the AC cable is too thin.Check the voltage difference between LCD and meter.
F44	AC Line V,W low voltage	Check the AC voltage protection setting. Check the voltage difference between LCD and meter. Also need to check whether AC cables are all firmly and correctly connected.
F45	AC Line U,V over voltage	Check the AC voltage protection setting.And Check if the AC cable is too thin.Check the voltage difference between LCD and meter.
F46	AC Line U,V low voltage	Check the AC voltage protection setting.
F47	AC Over frequency	Check the frequency protection setting.
F48	AC lower frequency	Check the frequency protection setting.
F49	U phase grid current DC component over current	Restart the inverter, if not ruled out, try contacting the installer /manufacturer customer service
F50	V phase grid current DC component over current	Restart the inverter, if not ruled out, try contacting the installer /manufacturer customer service
F51	W phase grid current DC component over current	Restart the inverter, if not ruled out, try contacting the installer /manufacturer customer service
F52	AC inductor A, phase current DC current high	Restart the inverter, if not ruled out, try contacting the installer /manufacturer customer service
F53	AC inductor B, phase current DC current high	Restart the inverter, if not ruled out, try contacting the installer /manufacturer customer service
F54	AC inductor C, phase current DC current high	Restart the inverter, if not ruled out, try contacting the installer /manufacturer customer service
F55	DC busbar voltage is too high	1. Check PV voltage and Ubus voltage and its detection circuit. If the PV input voltage exceeds the limit, please reduce the number of solar panels in series. 2. For Ubus voltage, please check the LCD display.
F56	DC busbar voltage is too low	1. It tells the PV input voltage is low and it always happens in the early morning. 2. Check PV voltage and Ubus voltage. When inverter is running, then showing F56, maybe Loss of driver or need update firmware. 3. Restart the inverter, if the fault still exists, contact your installer.
F57	AC reverse irrigation	AC reverse irrigation.
F58	AC grid U over current	Restart the inverter, if not ruled out, try contacting the installer /manufacturer customer service

Error code	Description	Ongrid - Three Phase
F59	AC grid V over current	Restart the inverter, if not ruled out, try contacting the installer /manufacturer customer service
F60	AC grid W over current	Restart the inverter, if not ruled out, try contacting the installer /manufacturer customer service
F61	Reactor A phase over current	Restart the inverter, if not ruled out, try contacting the installer /manufacturer customer service
F62	Reactor B phase over current	Restart the inverter, if not ruled out, try contacting the installer /manufacturer customer service
F63	ARC fault	1. Check PV module cable connection and clear the fault; 2. Seek help from us, if can not go back to normal state.
F64	IGBT heat sink high temperature	1. Check temperature sensor. Check if firmware is suitable for the hardware. Check if the inverter is its right model. 2. Restart the inverter, if the fault still exists, contact your installer.

Table10.1 Error codes and their solutions



**Safety Hint:**

If your string inverter has any of the fault information shown in Table 10-1, and when you reset the machine and still don't solve the problem, please contact our distributor and provide the below details:

1. Serial number of the inverter;
2. The distributor/dealer of the inverter(if available);
3. Installation date;
4. The discription of problem(include LCD'error code and LED starus indicator lights);
5. Your contact details.

# 11. Specification

Model	FE-120-3P-OG	FE-125-3P-OG	FE-130-3P-OG
<b>PV String Input Data</b>			
Max. PV Input Power(kW)	180	187.5	195
Max. PV Input Voltage(V)	1100		
Start-up Voltage(V)	250		
PV Input Voltage Range(V)	250-1100		
MPPT Voltage Range(V)	200-1000		
Rated PV Input Voltage(V)	600		
Full Load MPPT Voltage Range(V)	550-850		
Max. Input Short Circuit Current (A)	60+60+60+60+60+60+60+60		
Max. Operating PV Input Current(A)	40+40+40+40+40+40+40+40		
No. of MPP Trackers/No. of Strings MPP Tracker	8/4+4+4+4+4+4+4+4		
Max. Inverter Backfeed Current To the Array	0		
<b>AC Output Data</b>			
Rated AC Output Active Power(kW)	120	125	130
Max.AC Output Apparent Power(kVA)	132	135	135
Rated AC Output current (A)	181.9/174.0	189.4/181.2	197/188.5
Max.AC Output Current(A)	200/191.4	204.6/195.7	204.6/195.7
Max. Output Fault Current (A)	348	362.4	377
Max. Output Overcurrent Protection (A)	398	398	398
Rated Output voltage/range (V)	220/380V 230/400V 0.85Un-1.1Un		
Grid Connection Form	3L+N+PE		
Rated Output Grid Frequency/range(Hz)	50Hz/45Hz-55Hz, 60Hz/55Hz-65Hz		
Power Factor Adjustment Range	0.8 leading-0.8lagging		
Total Current Harmonic Distortion THDi	<3%		
DC Injection Current	<0.5In		
<b>Efficiency</b>			
Max.Efficiency	98.8%		
Euro Efficiency	98.2%		
MPPT Efficiency	>99%		
<b>Equipment Protection</b>			
DC reverse polarity protection	yes		
AC Output Overcurrent Protection	yes		
AC Output Overvoltage Protection	yes		
AC Output Short Circuit Protection	yes		
Thermal Protection	yes		
Insulation Impedance detection	yes		
DC Component Monitoring	yes		
Arc fault circuit interrupter (AFCI)	Optional		
Anti-islanding protection	yes		
DC Switch	yes		
Residual Current Detection	yes		
Surge Protection Level	TYPE II(DC),TYPE II(AC)		

<b>Interface</b>	
Communication Interface	RS485/RS232
Monitor Mode	GPRS/WIFI/Bluetooth/4G/LAN(optional)
Display	LCD+LED
<b>General Data</b>	
Operating Temperature Range (°C)	-25 to +60°C, >45°C derating
Permissible Ambient Humidity	0-100%
Permissible Altitude (m)	4000m
Noise (dB)	≤ 65dB
Ingress Protection(IP) Rating	IP 65
Inverter Topology	Non-Isolated
Over Voltage Category	OVC II(DC), OVC III(AC)
Cabinet Size (W*H*D) [mm]	1006×516×325.5 (Excluding connectors and brackets)
Weight [kg]	103
Warranty [year]	Standard 5 years, extendable warranty
Type Of Cooling	Intelligent air cooling
Grid Regulation	IEC 61727, IEC 62116, CEI 0-21, CEI 0-16, EN 50549, NRS 097, RD 140, UNE 217002, OVE-Richtlinie R25, G99, VDE-AR-N 4105, VDE-AR-N 4110
Safety EMC/Standard	IEC/EN 61000-6-1/2/3/4, IEC/EN 62109-1, IEC/EN 62109-2

Model	FE-135-3P-OG	FE-136-3P-OG
<b>PV String Input Data</b>		
Max. PV Input Power(kW)	202.5	204
Max. PV Input Voltage(V)	1100	
Start-up Voltage(V)	250	
PV Input Voltage Range(V)	250-1100	
MPPT Voltage Range(V)	200-1000	
Rated PV Input Voltage(V)	600	
Full Load MPPT Voltage Range(V)	550-850	
Max. Input Short Circuit Current (A)	60+60+60+60+60+60+60+60	
Max. Operating PV Input Current(A)	40+40+40+40+40+40+40+40	
No. of MPP Trackers/No. of Strings MPP Tracker	8/4+4+4+4+4+4+4+4	
Max. Inverter Backfeed Current To the Array	0	
<b>AC Output Data</b>		
Rated AC Output Active Power(kW)	135	136
Max.AC Output Apparent Power(kVA)	135	136
Rated AC Output current (A)	204.6/195.7	206.1/197.2
Max.AC Output Current(A)	204.6/195.7	206.1/197.2
Max. Output Fault Current (A)	391.4	394.4
Max. Output Overcurrent Protection (A)	398	398
Rated Output voltage/range (V)	220/380V 230/400V 0.85Un-1.1Un	
Grid Connection Form	3L+N+PE	
Rated Output Grid Frequency/range(Hz)	50Hz/45Hz-55Hz, 60Hz/55Hz-65Hz	
Power Factor Adjustment Range	0.8 leading-0.8lagging	
Total Current Harmonic Distortion THDi	<3%	
DC Injection Current	<0.5%In	
<b>Efficiency</b>		
Max.Efficiency	98.8%	
Euro Efficiency	98.2%	
MPPT Efficiency	>99%	
<b>Equipment Protection</b>		
DC reverse polarity protection	yes	
AC Output Overcurrent Protection	yes	
AC Output Overvoltage Protection	yes	
AC Output Short Circuit Protection	yes	
Thermal Protection	yes	
Insulation Impedance detection	yes	
DC Component Monitoring	yes	
Arc fault circuit interrupter (AFCI)	Optional	
Anti-islanding protection	yes	
DC Switch	yes	
Residual Current Detection	yes	
Surge Protection Level	TYPE II(DC),TYPE II(AC)	

<b>Interface</b>	
Communication Interface	RS485/RS232
Monitor Mode	GPRS/WIFI/Bluetooth/4G/LAN(optional)
Display	LCD+LED
<b>General Data</b>	
Operating Temperature Range (°C)	-25 to +60°C, >45°C derating
Permissible Ambient Humidity	0-100%
Permissible Altitude (m)	4000m
Noise (dB)	≤ 65dB
Ingress Protection(IP) Rating	IP 65
Inverter Topology	Non-Isolated
Over Voltage Category	OVC II(DC), OVC III(AC)
Cabinet Size (W*H*D) [mm]	1006×516×325.5 (Excluding connectors and brackets)
Weight [kg]	103
Warranty [year]	Standard 5 years, extendable warranty
Type Of Cooling	Intelligent air cooling
Grid Regulation	IEC 61727, IEC 62116, CEI 0-21, CEI 0-16, EN 50549, NRS 097, RD 140, UNE 217002, OVE-Richtlinie R25, G99, VDE-AR-N 4105, VDE-AR-N 4110
Safety EMC/Standard	IEC/EN 61000-6-1/2/3/4, IEC/EN 62109-1, IEC/EN 62109-2

## **FESTON S.E.V PRIVATE LIMITED**

Add.: 3rd Floor, No.97/80, Vanagaram Service Road, Athipattu,  
Ambattur, Chennai, Tamil Nadu, 600058, India

Tel.: +91 8925827701

E-mail: [sales@festonsev.com](mailto:sales@festonsev.com)

Web.: [www.festonsev.com](http://www.festonsev.com)